



YEONG CHIN MACHINERY INDUSTRIES CO., LTD.

No. 888, Sec. 1, Homu Road, Shengang District, Taichung 42953, Taiwan

Tel : +886-4-2562-3211

■ Fax: +886-4-2562-6479

Web Page: www.YCMCNC.com

■ Email: sales@YCMCNC.com



202003-E01-1000

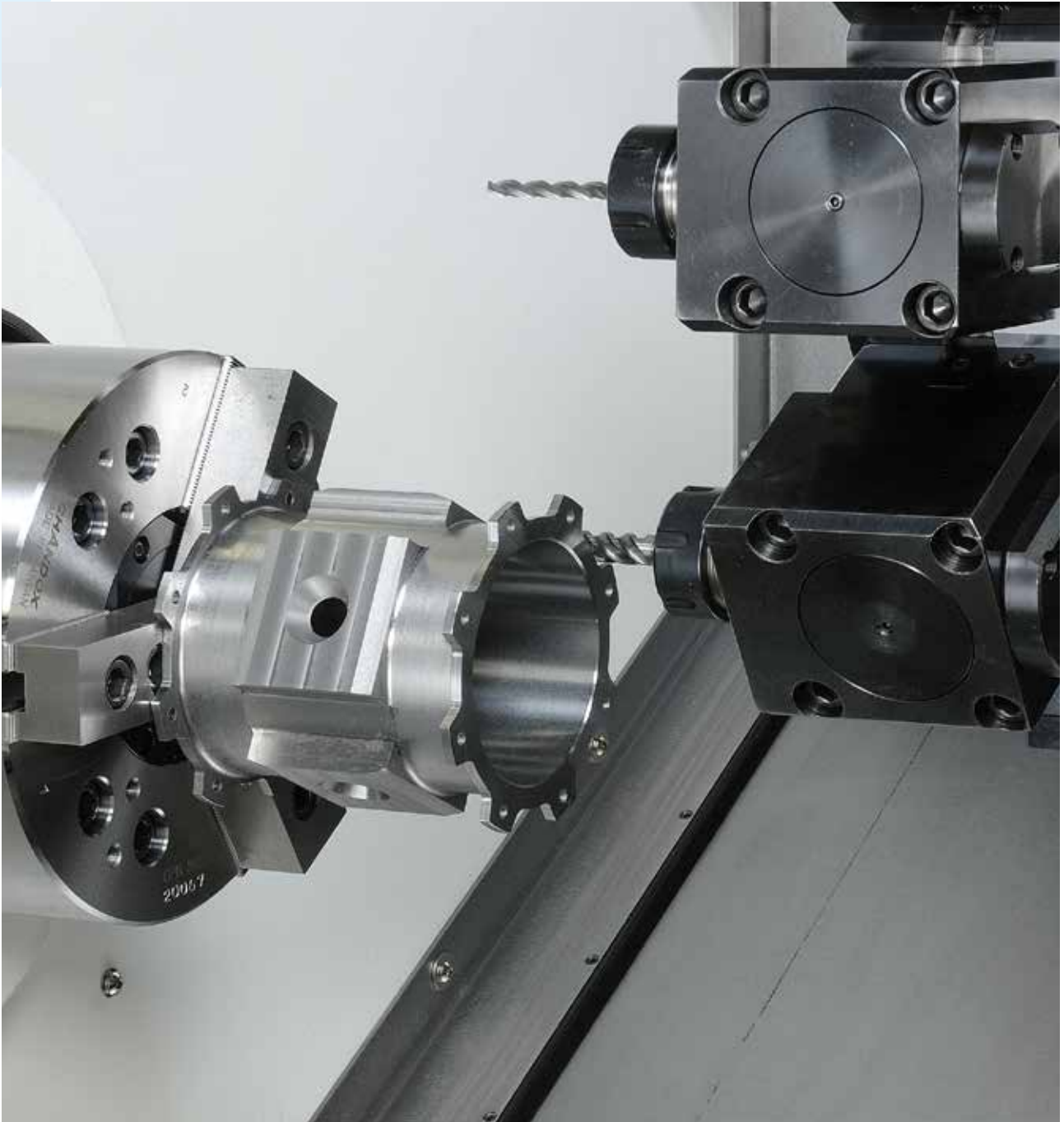

CNC Turning Center



CNC Turning Center

GT



Ideal for Hard Material Machining

The GT Series includes a range of machines from 6" - 12" chucks, with rigid flat bed, 2-axis boxway construction and heavy-duty ballscrews, allowing high metal removal rates. Backed by a robust structure and high torque spindle, ensures machining stability in hard, or tough to machine materials.

TC



Ideal for General Machining (TC-16)

The TC-16 models are available with 6" & 8" chuck sizes, feature a 45° slant bed structure, linear guides, and are best suited for general purpose, high productivity, 2-axis machining.

Ideal for Heavy Duty Machining (TC-26, 36, 46, & 46M)

The TC-26 & 36 models are available with 10" & 12" chuck sizes and the TC-46/46M are available with 15" - 24" chuck sizes.

These heavy duty machines also feature a 45° slant bed design, robust box way construction, and powerful high torque geared-head spindle, making them ideal for heavy machining applications. With Z-axis travels from 700mm ~ 3,200mm [27.56" ~ 125.98"](#) these machines offer spacious working area to machine large-sized workpieces, such as valves, shafts and hydraulic components for the aerospace, automotive, power generation, shipbuilding, construction, and oil/gas industries.



To meet high customer expectations, YCM offers a comprehensive range of CNC turning centers with a variety of chuck sizes, bed lengths, and optional performance features & functions. Our strategically designed MEEHANITE® cast iron structures provide high rigidity for heavy cutting, precision tolerances and fine surface finishes. These products meet the demanding requirements for multiple industries such as automotive, medical and job shop.

NTC



Configurable Design for Complex Machining

NTC models are available with 8" chuck size, feature a 30° slant bed structure with robust boxway construction. The NTC's highly modular design allows customers to choose from a variety of machine configurations of turret, tailstock, sub spindle and Y-axis that best fits their application to complete the most complex jobs in a single setup.

NT



High Productivity Design, Heavy Duty Structure

NT models are available with 10" chuck size, feature a robust 30° slant bed structure with boxway construction. With standard high productivity features like Y-axis, sub spindle, and C-axis, complex parts can be completed in a single setup maximizing production efficiency.



GT

Rigid Boxway
Turning Center



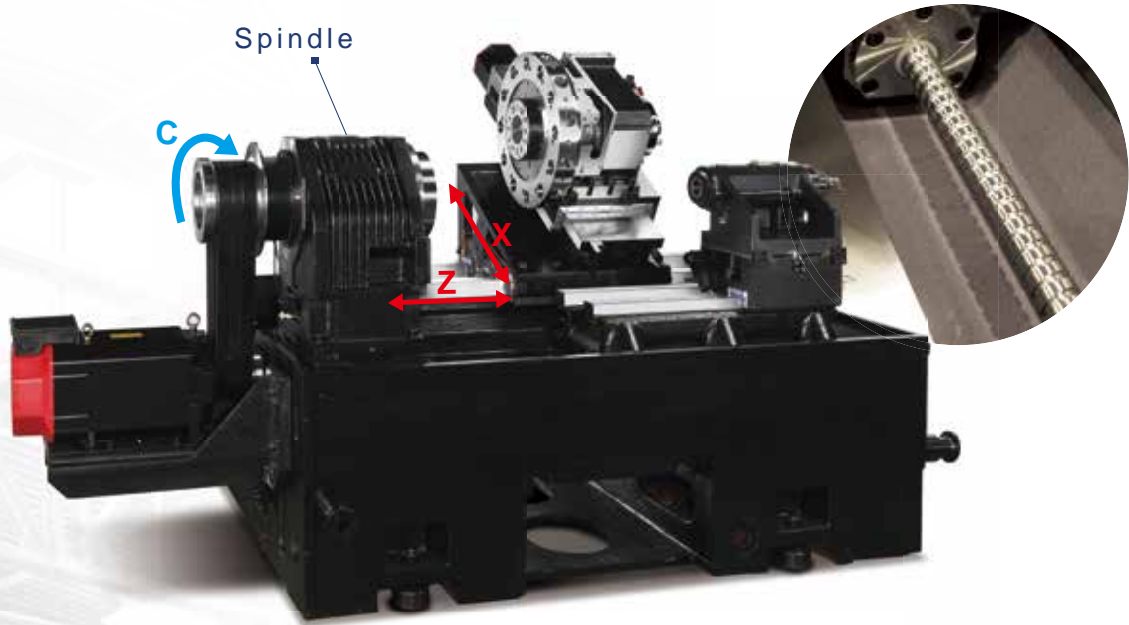

Strategically Designed Structure

The heavy-duty base design incorporates large boxways and all castings are made from high quality, durable MEEHANITE® cast-iron providing high rigidity and stability during heavy machining operations.



Model	Structure	Box Ways	Anti-distortion	Dampening Capacity
GT Series	Strengthened	Extra-large	Enhanced	Enhanced
Competitors	General	General	General	General

Thermally Stable Design

- Symmetrically designed headstock combined with effective spindle headstock exhaust fans provide superior ventilation throughout the spindle compartment, help to minimize thermal growth.
- The spindle motor is mounted to the left side of the machine base and is designed to exhaust the heat generated from spindle motor away from the machine structure.
- Isolated coolant tank minimizes the effect of coolant temperature fluctuation, reducing potential structural deformation.
- High-performance hydraulic piston pump provides high efficiency and low heat minimizing the thermal impact of hydraulic system.

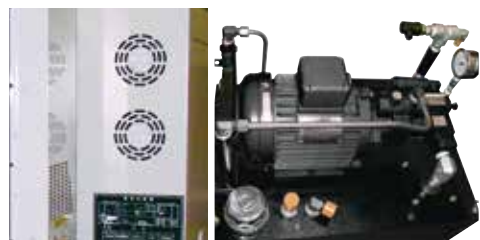

High Performance Spindle

- YCM cartridge-type spindles are designed utilizing robust dual-roller bearings that provide high stiffness, rigidity and durability.
- Built to high quality standards in our spindle head room, these spindles provide high performance machining capability and long service life.



Spindle Power – Torque Diagram

Power		Torque	
Low	High	Low	High

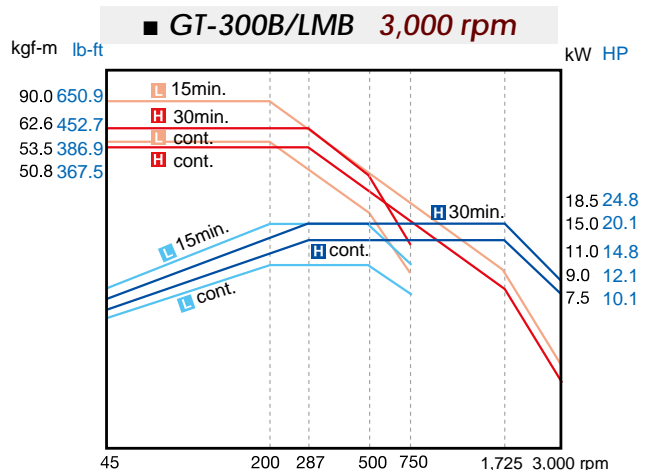
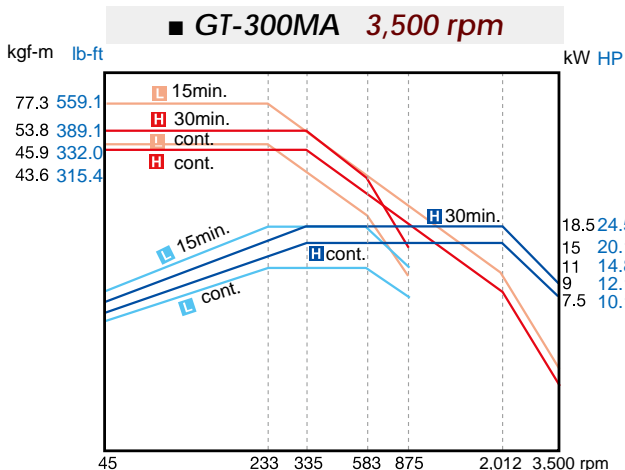
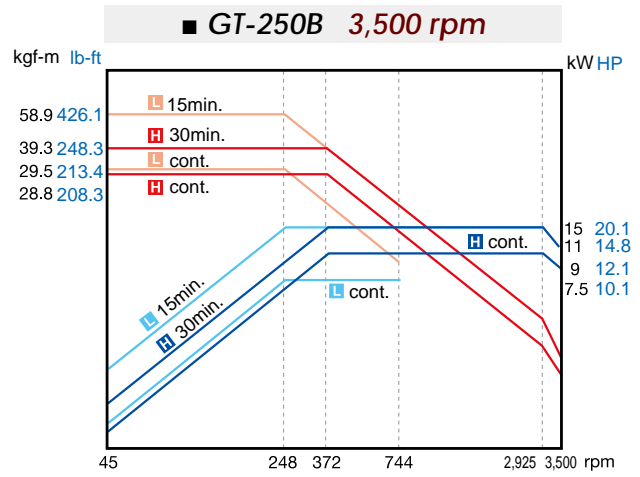
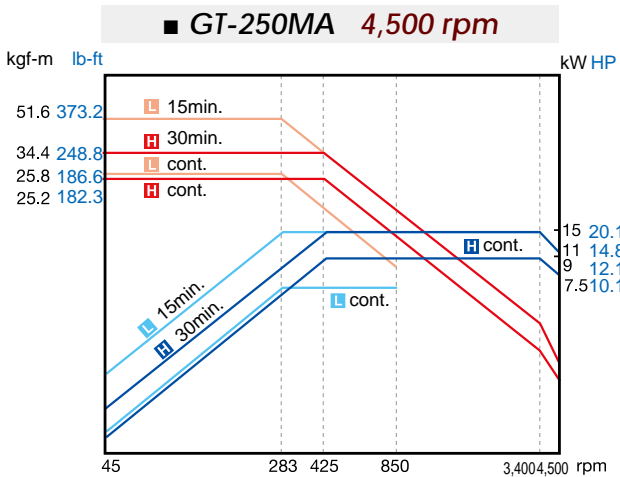
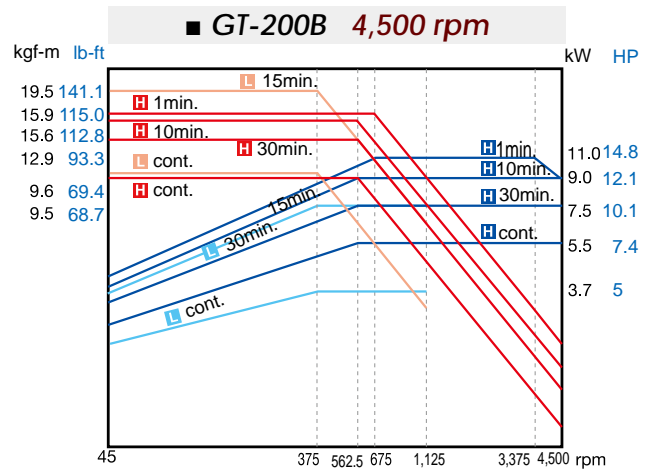
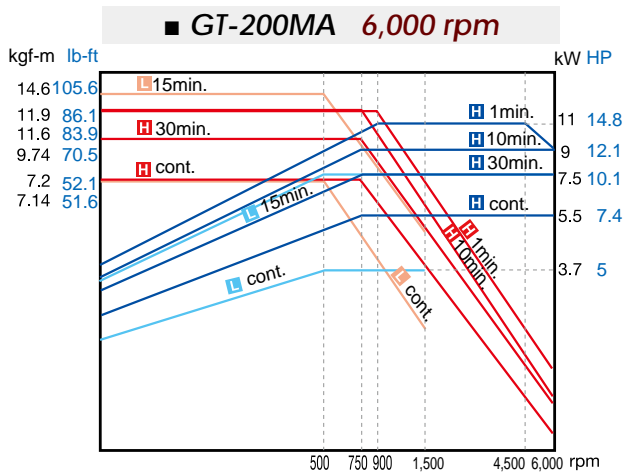

VDI Turret Machining Capacity

	GT-200MA	GT-250MA GT-300MA/LMB
Turning Tool Post	VDI 30 DIN69880	VDI 40 DIN69880
Milling Tool Post	VDI 30 DIN69880 DIN1809	VDI 40 DIN69880 DIN1809
Collet Type	ER25	ER32
Max. Milling Tool Dia.	ø16 mm ø0.63"	ø20 mm ø0.79"
Max. Drilling Tool Dia.	ø14 mm ø0.55"	ø20 mm ø0.79"
Max. Tapping Tool Dia.	M12 x 1.75P	M16 x 2P
End Milling Capacity	ø16 x 6 mm ø0.63 x 0.24"	ø20 x 10 mm ø0.79 x 0.39"
Rigid Tapping Capacity	M6 x 1P	M6 x 1P

The table above shows the test results on the material S45C. The results are provided as example. They may not be obtained due to differences in cutting conditions and environmental conditions during measurement.

VDI Live Tool Motor Torque Chart

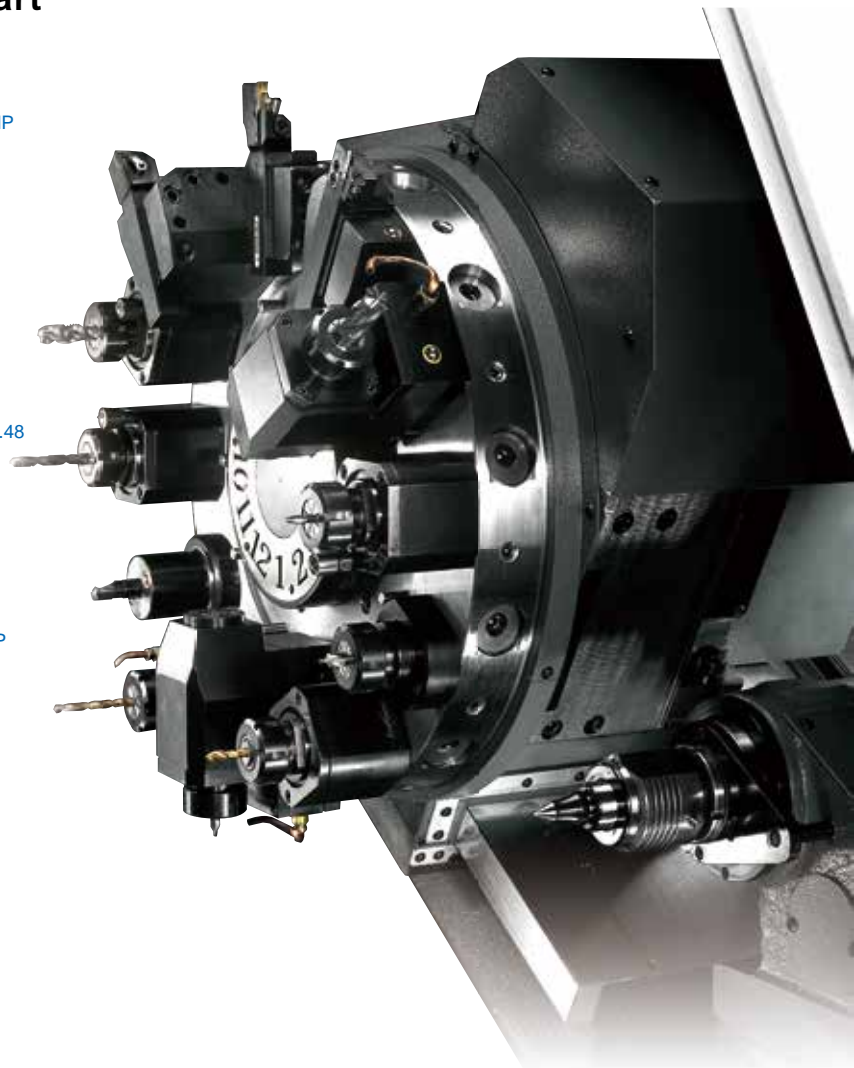
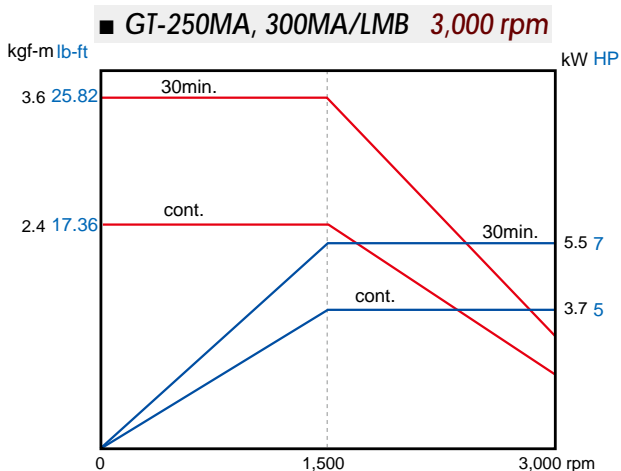
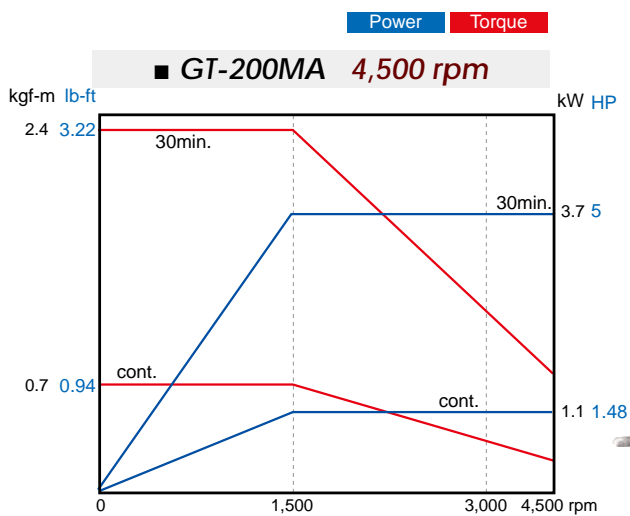

TC

Broad Range of
2-Axis Turning Centers



TC- 16LA / LB

Stable Base Structure

- One-piece 45° slant bed base is made of high quality MEEHANITE® cast iron that provides high stiffness and damping characteristics.
- This series offers the largest machining capacity in its class, with a max. turning diameter of $\varnothing 260$ mm $\varnothing 10.24$ " and a max. turning length of 600 mm 23.62"

Accurate and Stable Axes System

- The X/Z-axis are fitted with high precision linear guideways, fixed pre-tensioned direct drive ballscrews for fast, accurate machining in a thermally stable design.

High Performance Spindle

- YCM spindle features large diameter roller-type bearings and angular contact ball bearings, providing the best radial and axial rigidity during heavy machining.
- All YCM spindles are assembled in our temperature controlled spindle room to ensure high quality, reliability, and long spindle life.

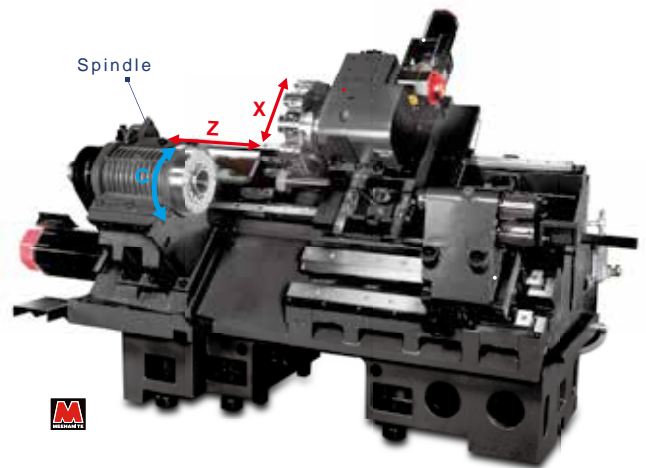

Fast, Reliable Turret

- Servo-driven turret with hydraulic clamping enables a faster tool change time.
- Large curvic coupling provides high stiffness, accurate positioning and repeatability accuracy.

Large Bar Capacity

- 6" chuck with hole through draw tube of $\varnothing 52$ mm $\varnothing 2.05$ "
- 8" chuck with hole through draw tube of $\varnothing 66$ mm $\varnothing 2.59$ "

Hydraulic System

- High efficiency plunger type hydraulic pump minimizes power loss and heat generation.

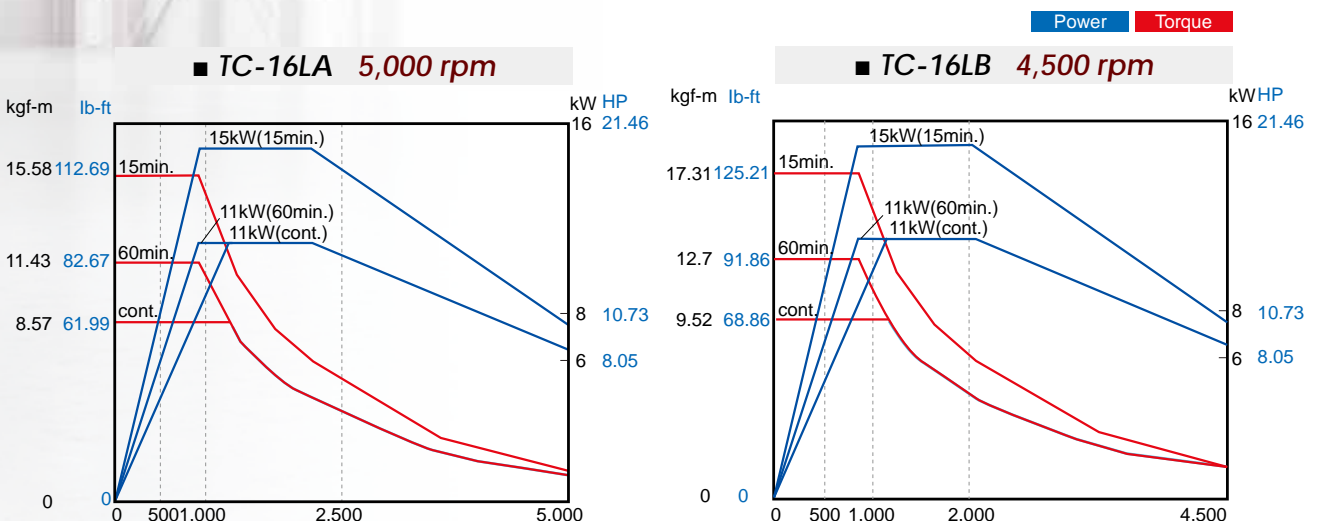

TC- 26 / 36

Stable Boxway Design

- The large harden and ground boxways are made from high quality MEEHANITE® cast iron providing the utmost rigidity during heavy cutting operations.
- Turcite-B on X/Z-axis provides superior rigidity, low friction coefficient, reduced vibration, and superior damping characteristics without stick-slip, while still maintaining machining accuracy.
- Up to 15/20 m/min **591/787 ipm** of rapid feedrate of X/Z-axis.

Robust Geared Head Spindle

- The geared head spindle design incorporates angular contact ball bearings, double-row roller bearings, and powerful geared head transmission providing high rigidity and stability during machining.



Programmable Tailstock

- "M" code commands, the quill stroke of the programmable tailstock. The tailstock body can be "hooked" to the carriage and be positioned along the Z-axis.
- Tailstock with live quill is standard.

Independent Coolant Tank

The ergonomic and easy to maintain coolant tank is separated from the machine, minimizing the influence of coolant temperatures providing a more thermally stable machine.



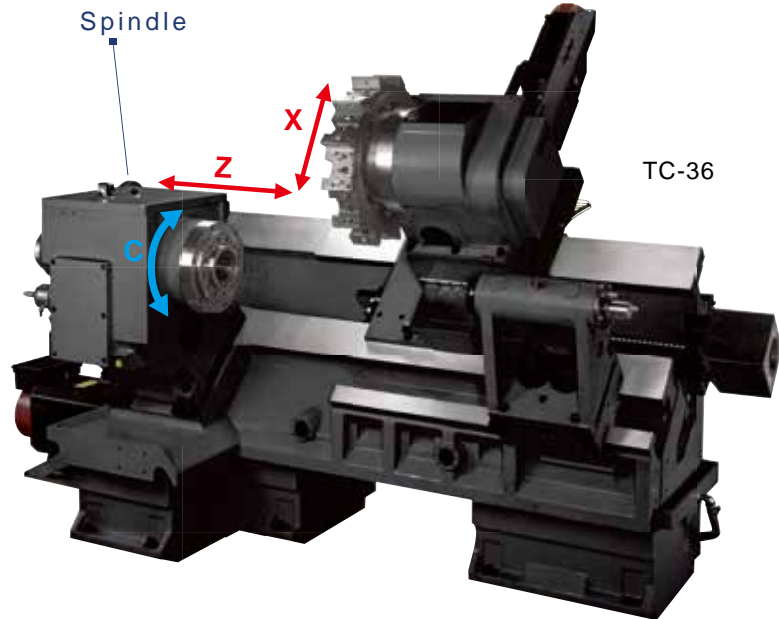
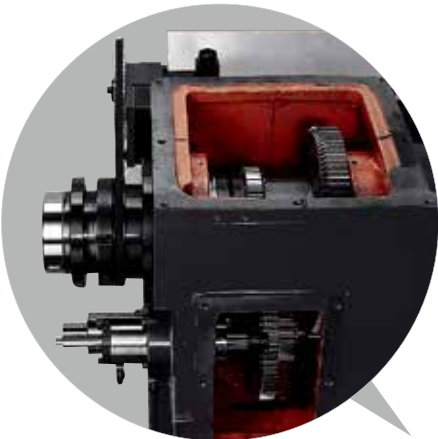

■ The multi-speed geared head transmission features 74.5 kgf-m **539 lb-ft** of max torque with spindle speeds up to 4,000 rpm. (TC-26)

■ This powerful multi-speed geared head transmission produces a massive max torque of 140 kgf-m **1,013 lb-ft**, with spindle speeds up to 2,500 rpm. (TC-36)

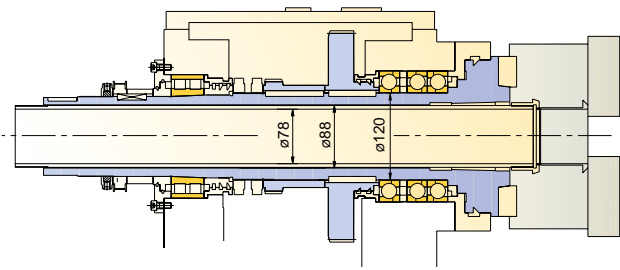
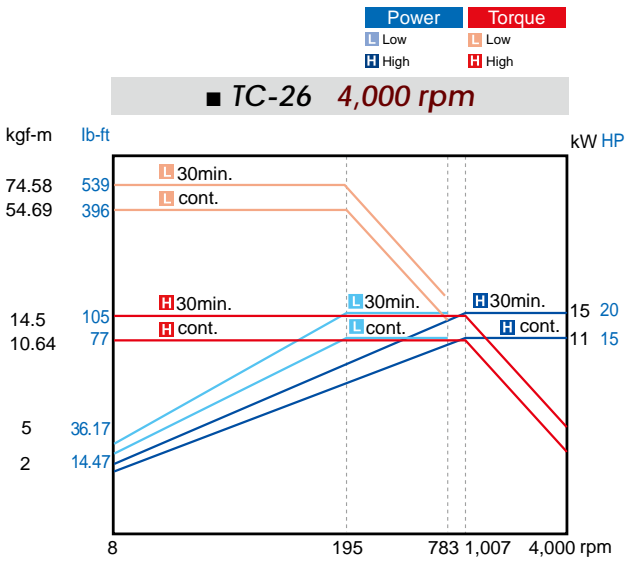

Bearing inner diameter: $\phi 120$ mm $\phi 4.72$ "
 Max. hole through spindle diameter: $\phi 88$ mm $\phi 3.46$ "
 Max. hole through draw tube diameter: $\phi 78$ mm $\phi 3.07$ "

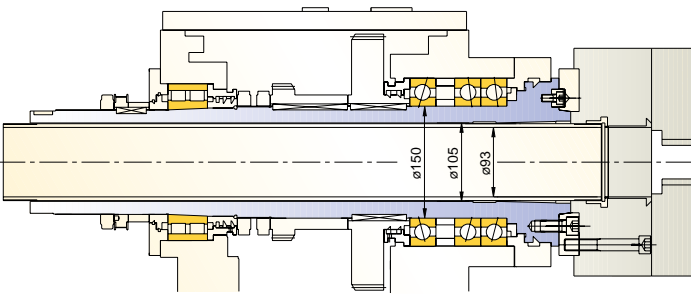
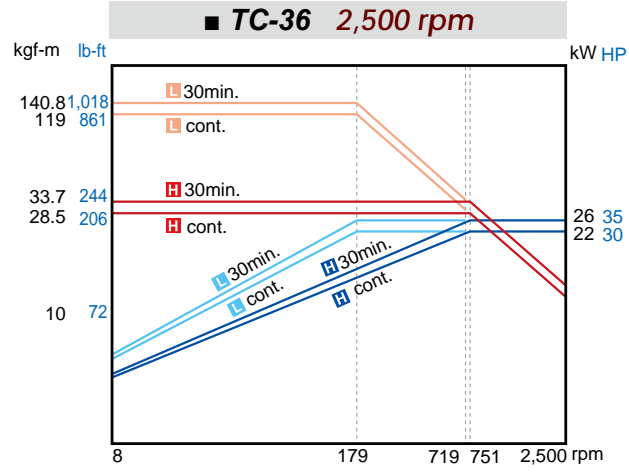

Bearing inner diameter: $\phi 150$ mm $\phi 5.91$ "
 Max. hole through spindle diameter: $\phi 105$ mm $\phi 4.13$ "
 Max. hole through draw tube diameter: $\phi 93$ mm $\phi 3.66$ "

TC- 46 / 46M

Rigid Structure Design

- Unlike some competitive turning centers with multiple-pieces base structures, YCM features one-piece base structure made from high quality, durable MEEHANITE® cast iron.
- Designed with a wide span between the two Z-axis boxways provides exceptional rigidity and stability during machining.



YCM (One-piece design)

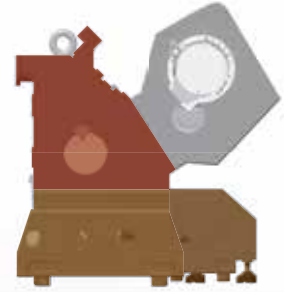

Others (Separate design)

Powerful Geared Head Spindle

- Massive maximum torque of 380 Nm **2,749 lb-ft** with spindle speeds up to 2,000 rpm.
- Standard with A2-11 spindle nose and 15" chuck.
- Optional 18"/21"/24" chucks with A2-15 spindle nose, big bore, and 1,200 rpm are also available.
- Large-diameter, heavy duty bearings provide high rigidity in heavy duty machining operations.

Extra-large Front Bearings

- Large front bearings with $\varnothing 180$ mm $\varnothing 7.09$ " ID enables large through hole capacity and ensures heavy duty cutting capability.
- Max. spindle through hole diameter: $\varnothing 130$ mm $\varnothing 5.12$ "
- Max. hole through draw tube diameter: $\varnothing 117$ mm $\varnothing 4.61$ "
- All TC spindles are precision ground, cartridge type and are assembled in our temperature controlled spindle room to ensure consistent assembly quality, high reliability, and long spindle life.

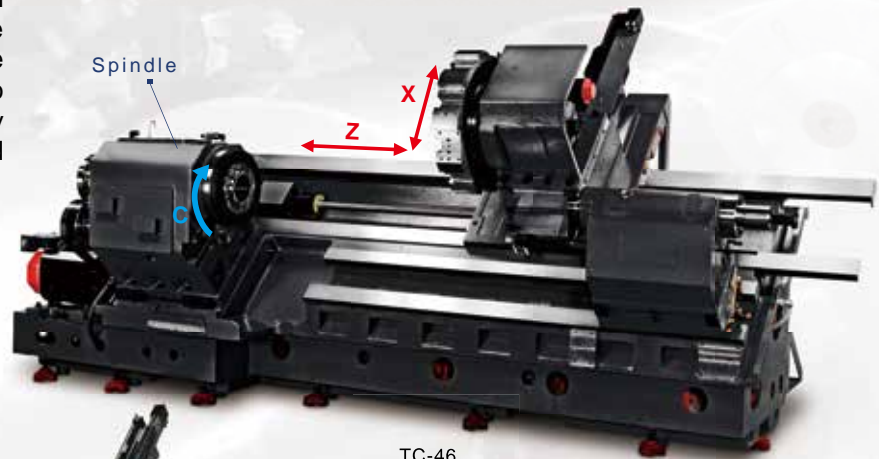

TC-46

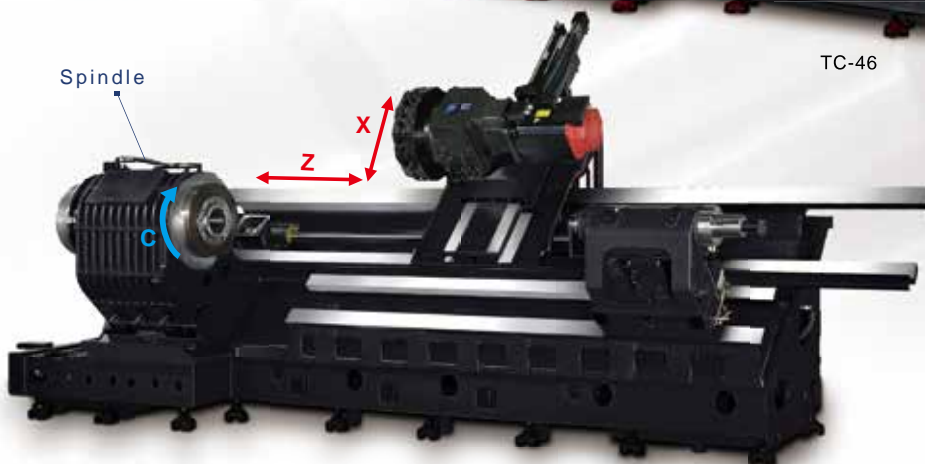

TC-46M

Big Hole through Spindle (opt.)

- A2-15 spindle with $\varnothing 182$ mm $\varnothing 7.17$ " bore, hole through draw tube $\varnothing 165$ mm $\varnothing 6.5$ " with a wide range of chuck size from 18" to 24".
- Suitable for long workpiece that require deep boring and drilling operations.

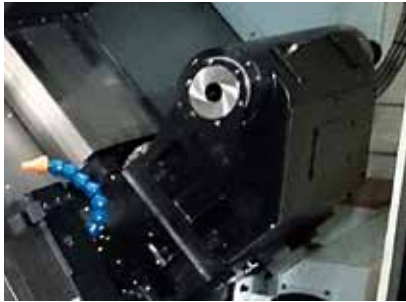
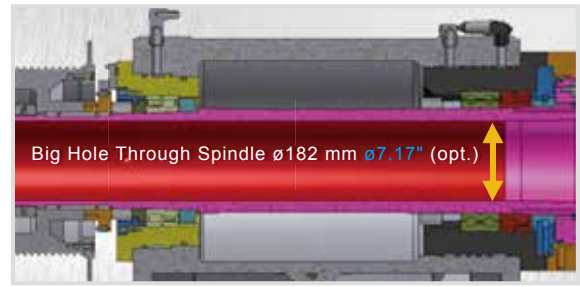

Fully Programmable Tailstock

- The tailstock is fully M-Code programmable.
- Provides rigid, firm support for extra-long workpieces to maximize machining precision.
- The MT-5 fixed quill with live center is included as standard. Live quill with dead center is optional.
- Two types of steady rests, manual-fixed and hydraulic-fixed. (opt.)

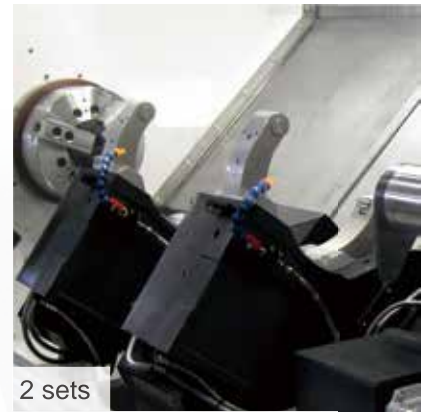
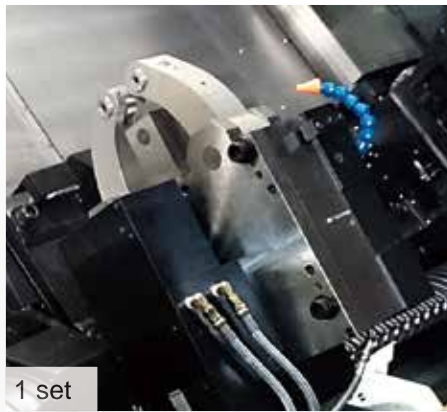

Manual steady rest (opt.)
 $\varnothing 40$ mm~ $\varnothing 250$ mm
 $\varnothing 1.57$ "~ $\varnothing 9.8$ "
 $\varnothing 250$ mm~ $\varnothing 460$ mm
 $\varnothing 9.8$ "~ $\varnothing 18.1$ "

TC-46M /3200
 Hydraulic steady rest (opt.)

TC-46M /3200
 Hydraulic steady rests (opt.)

Efficient Chip Disposal System

- The 45 degree slant bed base design provides efficient chip removal and a spacious working area.
- Chip wash-down is supplied for optimal chip removal.
- Shower coolant, mounted from the roof helps to prevent chips from accumulating in the work area. (opt.)



Spindle Power – Torque Diagram

Power Torque

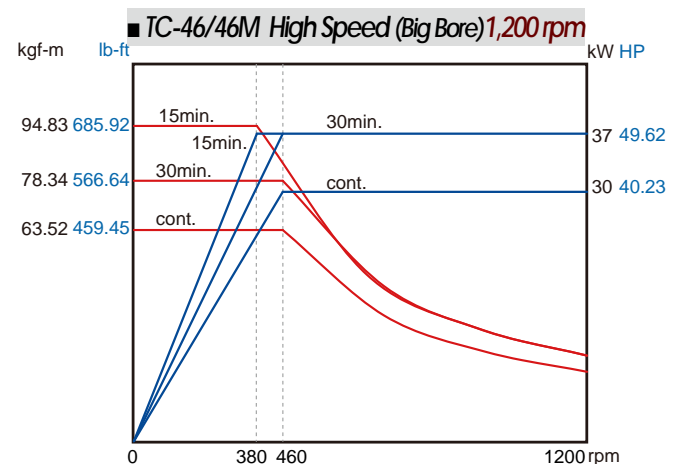
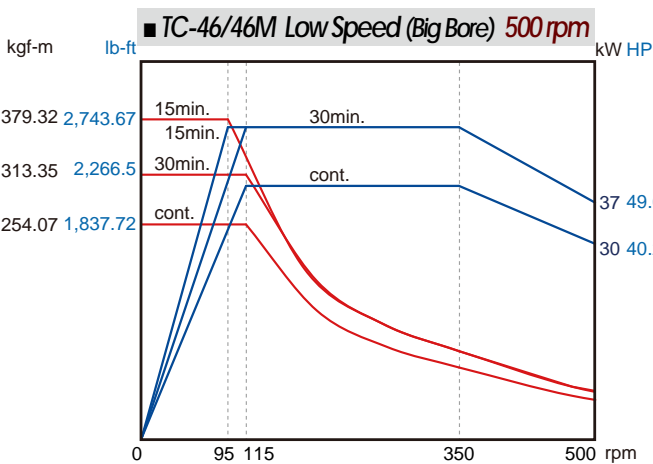
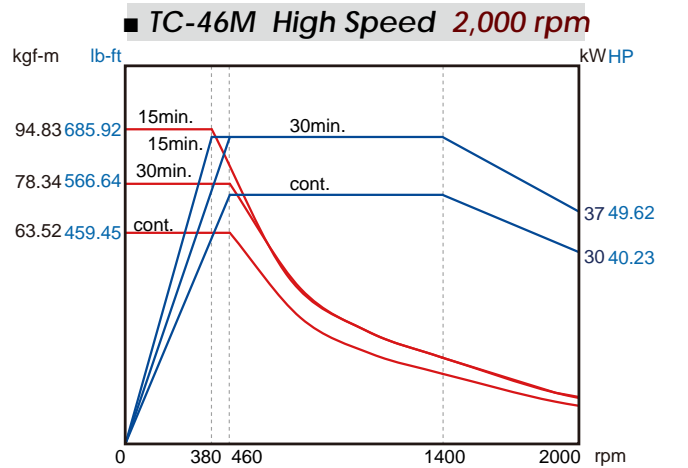
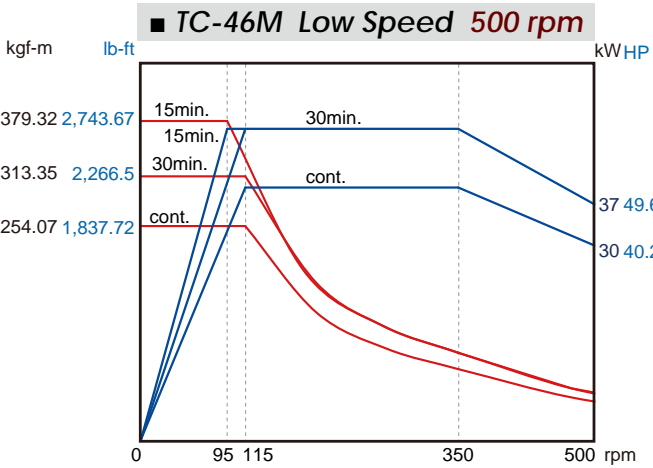
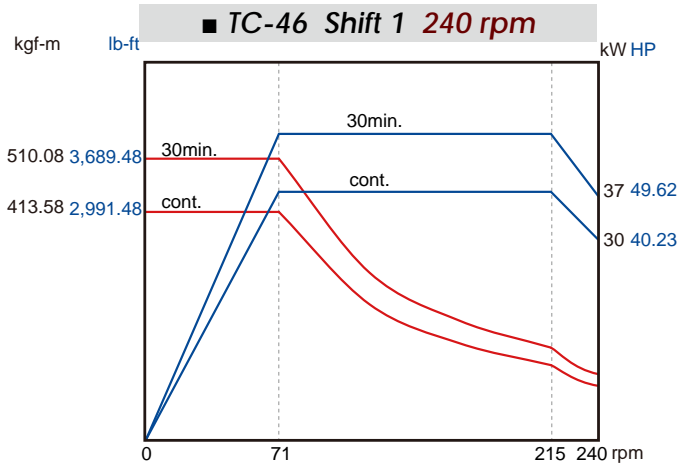
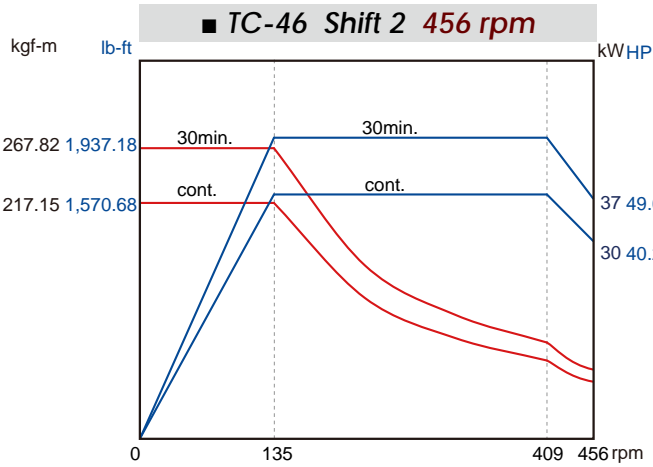
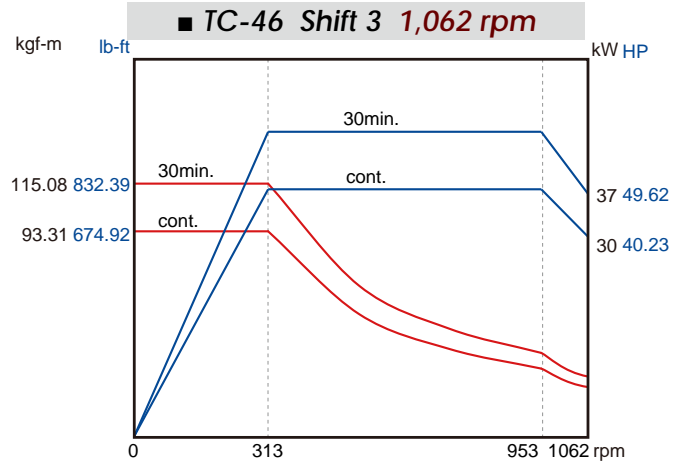
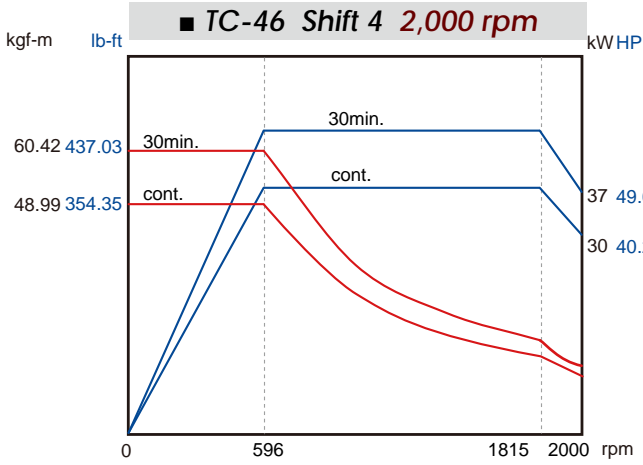

Fast and Reliable Servo Turret (TC-46)

Equipped with Large Servo Turret

- Robust 10-station, block type, servo driven turret with fast 0.9 sec. rotation time boosts efficiency and productivity.
- Optional 12-station, block type, servo driven turret.
- Optional BMT 85 12-station live tooling turret is available for heavy milling operations.

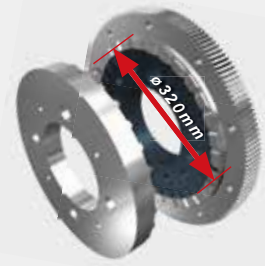

Large Diameter Curvic Coupling

The large diameter 3-piece curvic coupling is designed to provide superior turret clamp force during heavy cutting operations and ensure long-term accuracy.

Powerful Machining Capability (TC-46)

Powerful Machining Capability

The powerful 4 speed geared head and robust high torque spindle enhances productivity by allowing extreme heavy-duty cutting operations.



Thermally Stable Spindle

The powerful spindle includes an oil-cooling system that greatly minimizing the heat generated by the geared head spindle during machining operations.

Ultimate Machining Solution (TC-46M)

- 2 speed geared head spindle with max. torque of 380 kgf-m **2,748.59 lb-ft** is driven by a powerful 30/37 kW **40/50 HP** spindle motor.
- The high torque spindle incorporates an oil-cooling system to ensure thermal stability
- C-axis spindle encoder provides accurate 0.001 degree positioning.

Fast, Reliable Servo Driven Turret (TC-46M)

- 12 station BMT 85 live tool turret is driven by a powerful servo motor. Live tooling power is an impressive 15/18.5/22 kW **20/25/30 HP** with a maximum rotary tool speed of 3,000 rpm.
- Robust 3-piece curvic coupling provides superior clamp force, enabling excellent performance on heavy-duty milling and turning operations.

NTC

High Efficiency,
8" Modular Turn-Mill Center



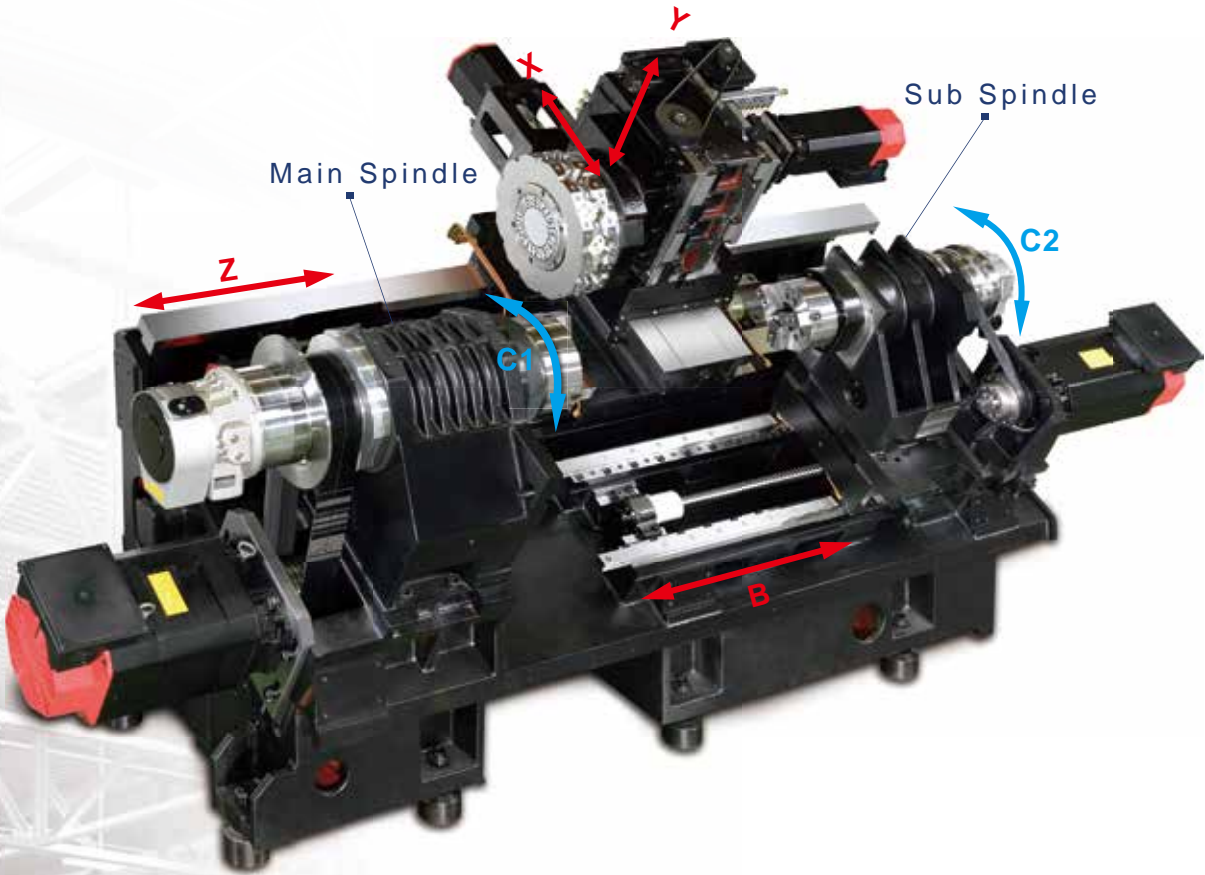

Robust One-Piece Base Structure

- One-piece 30° slant bed design made from high quality MEEHANITE® cast-iron.
- Turcite-B on X/Z-axis provides superior rigidity, low friction coefficient, reduced vibration, and superior damping characteristics without stick-slip, while still maintaining machining accuracy.

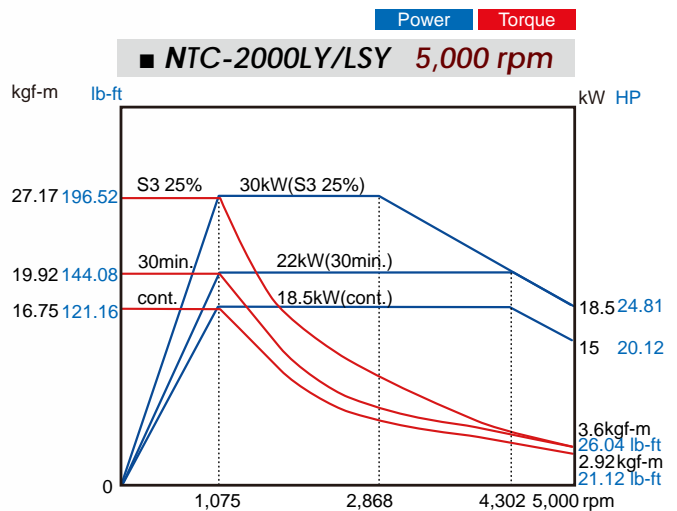
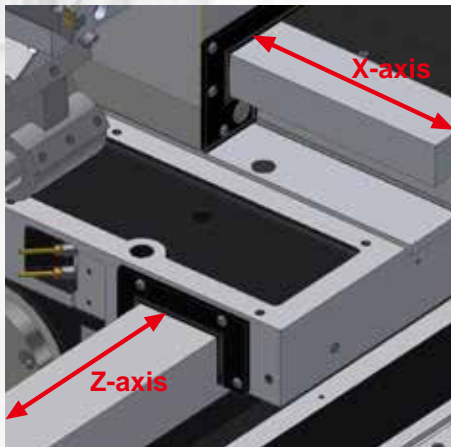

Integrated Sub Spindle and Y-axis for Complete Part Machining

- The orthogonal Y-axis design allows complex off center milling, drilling, and tapping in a single setup eliminating the need for a secondary milling operations.
- The combination of sub spindle and Y-axis allows the complete machining of prismatic parts in a single setup improving efficiency and accuracy due to less part handling and completing the part in one setup, compared to using multiple machines.

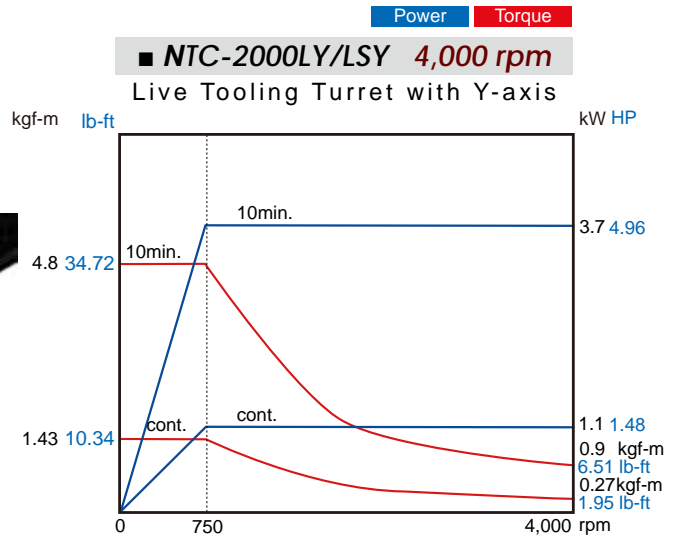

Flexible Manufacturing Solution

- Optional sub spindle with 6" chuck, or 2 different types of optional tailstocks are available depending on the customers production requirements. Choose either a fully programmable hydraulic tailstock, or servo-driven tailstock.
- Manually positioned tailstock with programmable quill is the standard configuration.

Model	NTC-2000LY		
Tailstock			
Tailstock Types	Manual Positioning Hydraulic Quill (std.)	Tow-Along Positioning Hydraulic Quill (opt.)	Servo Positioning Servo Hold (opt.)
Quill Stroke	100 mm 3.94"	100 mm 3.94"	-
Quill Taper	MT-4		
Center	Fixed type		

Sub Spindle with 6" Chuck for NTC-2000LSY







Max. sub spindle speed:
6,000 rpm
Max. sub spindle power:
7.5/11 kW 10.06/14.75 HP

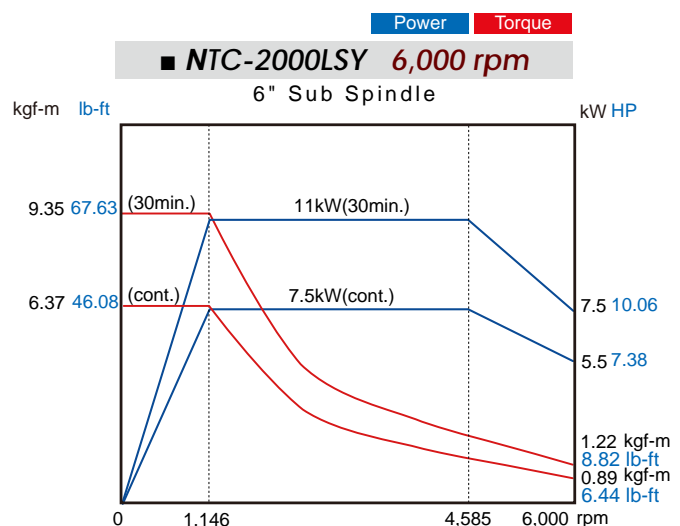

Magnetic encoder and brake on C-axis

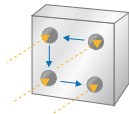

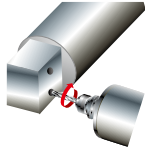
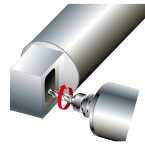
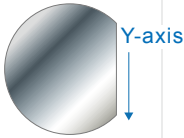
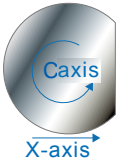
Efficient Combination of Y & C-axis

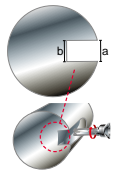
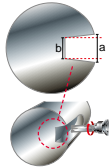
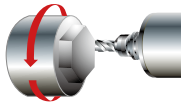
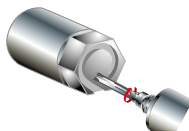
	Y & C-axis	C-axis
End Face Drilling	<p>○ Fast</p> 	<p>○ Slow</p> 
Off-center Drilling	<p>○</p> 	<p>X</p>
Off-center Side Grooving	<p>○</p> 	<p>X</p>
Large Face Milling	<p>○ Fast</p> 	<p>○ Slow</p> 
Contouring	<p>○ Finish Surface Without Pin Points</p> 	<p>X Rough Surface</p>
Keyway Machining	<p>○ High Accuracy</p> 	<p>○</p> 
X & C-axis Polar Interpolation	<p>○ Fast</p> 	<p>○ Slow</p>
X & Y-axis Circular Interpolation	<p>○ Fast</p> 	<p>○ Slow</p>

NT

High Efficiency,
10" Turn-Mill Center



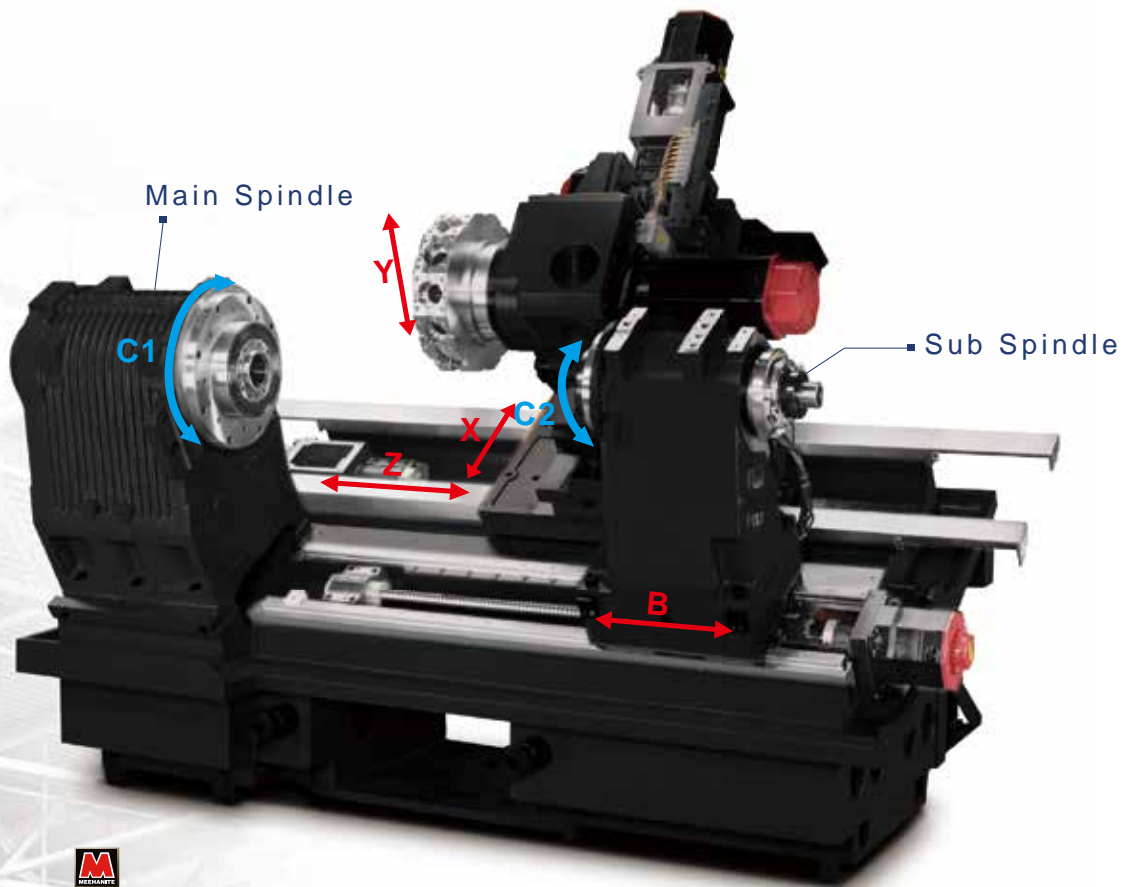

Reinforced Base Structure

- One-piece 30° slant bed design made from high quality MEEHANITE® cast-iron.
- The rigid structure is designed with high dampening characteristics to reduce the effects of vibration and minimize thermal deformation.
- The robust box ways are heat treated through an induction hardening process and precision ground to achieve optimal rigidity, accuracy and long service life.
- Designed with a wide span between the two Z-axis boxways provides exceptional rigidity and stability during machining.

High Speed Servo Turret

- Turret index and rotation is controlled by servo motor, enabling reliable and fast tool index times.

Single-setup Efficiency

- Packed with sub spindle, Y-axis and live tool turret, these turn-mill features allow complex finished parts machining in just one setup, while also improving efficiency and accuracy.
- X/Y/Z/B-axis are equipped with direct drive motors to enable high-accuracy positioning and repeatability.

YCM Manufactured Built-in-type Motorized Spindle

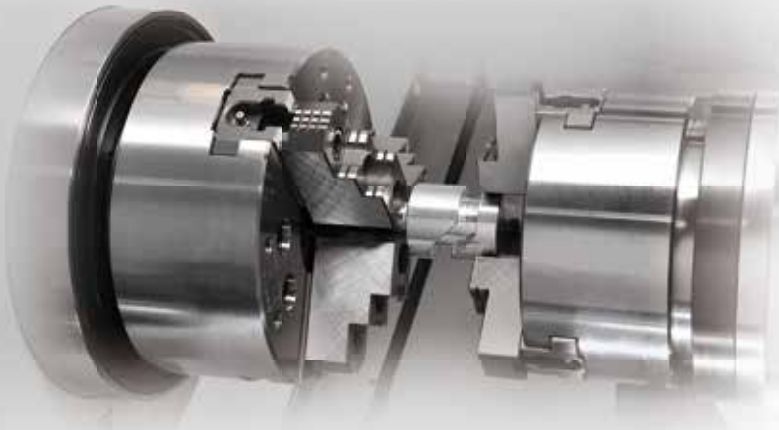

- Built-in spindles are more accurate and responsive compared to analog spindle drives, motors and belts. The motor is more reliable and requires minimal maintenance, since it is liquid cooled, brushless, permanently sealed and lubricated.
- The spindle chiller circulates oil around the spindle and controls the temperature minimizing thermal deformation.
- The spindle utilizes large diameter bearings that improves rigidity and cutting capability.
- C-axis index: 0.001°.

Spindle Power – Torque Diagram

Power		Torque	
Low	High	Low	High

■ NT-2500SY Main Spindle 3,500 rpm

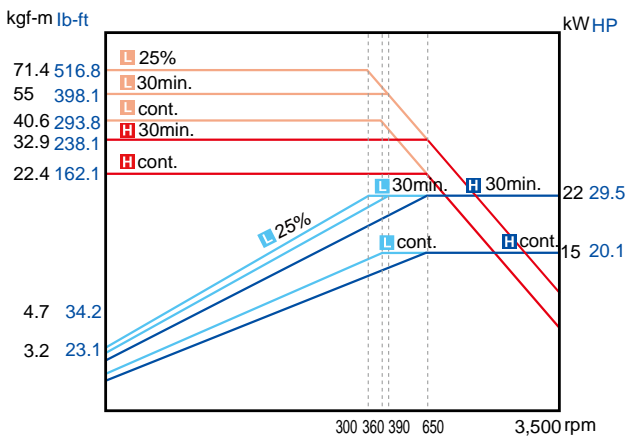

■ NT-2500SY Sub Spindle 6,000 rpm

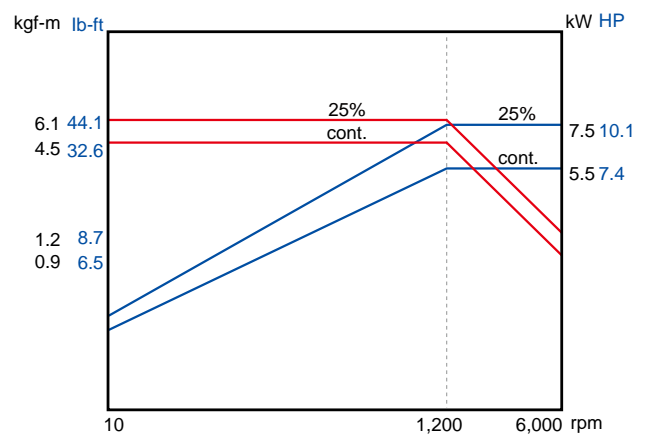

Continuous Machining Capability

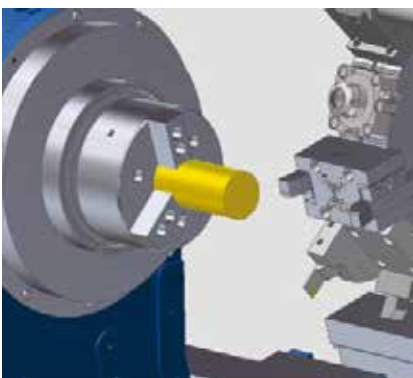

Main Spindle

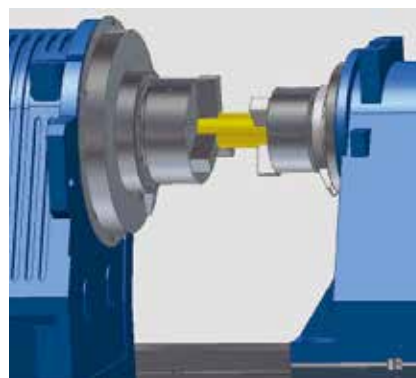

Transfer, or cut-off and transfer from main to sub spindle

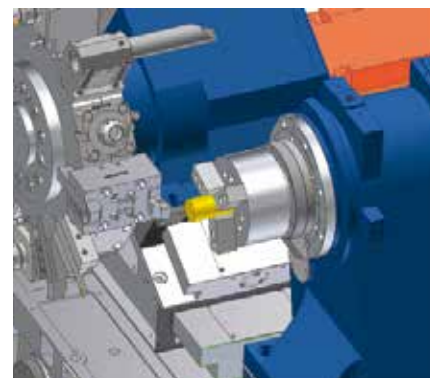

Sub Spindle

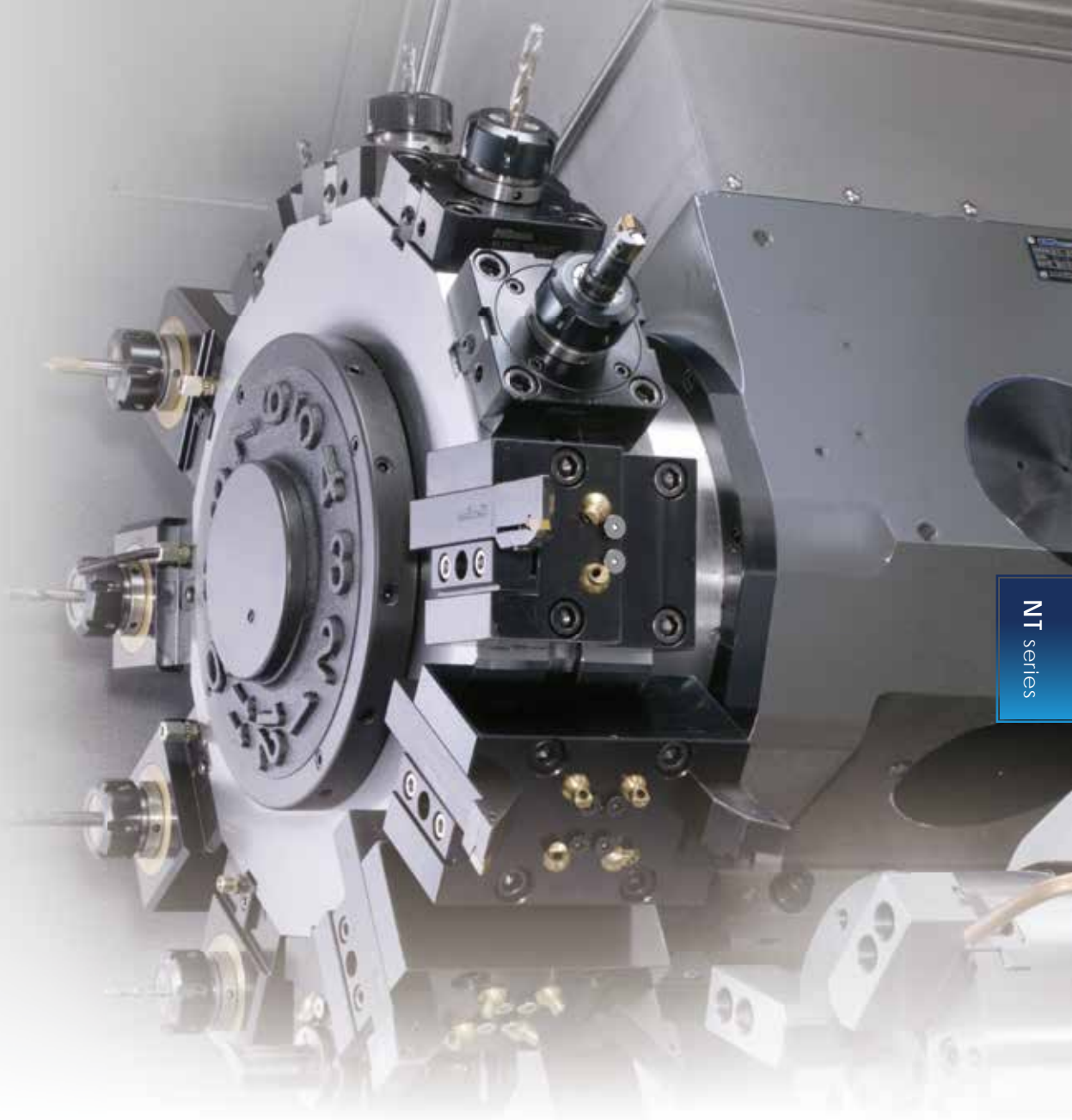

High Speed Servo Driven Turret

- BMT65 live tooling turret with 12 stations minimizes interference as the part is turned and milled.
- The servo driven turret is designed with large diameter curvic coupling and hydraulic clamping system that provides high clamping force, along with precise turret positioning and repeatability accuracy.

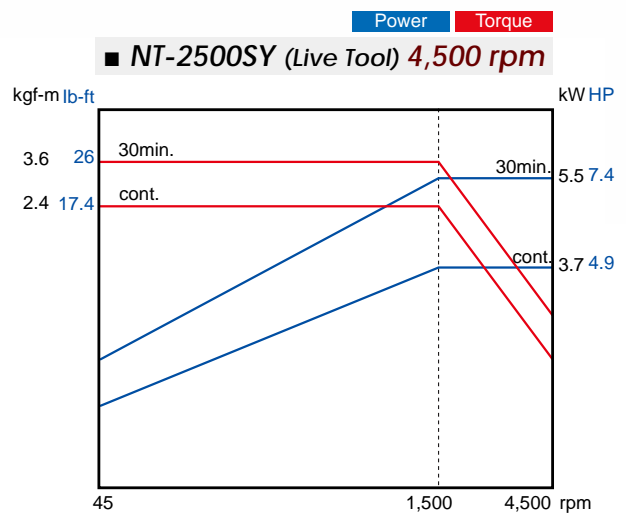

- Max. live tool power: 5.5 kW 7.38 HP
- Index time: 0.18 sec.

TOOLING CHART

GT

Unit: mm inch

● Standard

○ Optional

■ GT-200B

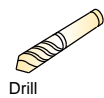
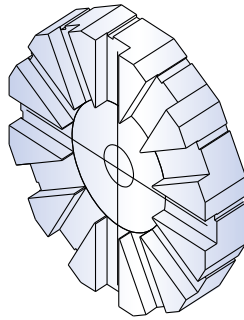

Drill



Drill Socket
 ● MT1-1PC
 ● MT2-1PC
 ● MT3-1PC
 ○ MT4

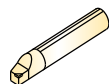

Boring Tool
 $\phi 40$ <math><\phi 1\ 1/2''</math>



Boring Bar Sleeve
 ● $\phi 32$ $\phi 1\ 1/4''$ - 2 PC
 ● $\phi 25$ $\phi 1''$ - 2 PC
 ● $\phi 20$ $\phi 3/4''$ - 1 PC
 ● $\phi 16$ $\phi 5/8''$ - 1 PC
 ● $\phi 12$ $\phi 1/2''$ - 1 PC
 ● $\phi 10$ $\phi 3/8''$ - 1 PC
 ● $\phi 8$ $\phi 5/16''$ - 1 PC
 ● $\phi 6$ $\phi 1/4''$ - 1 PC

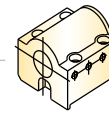

Boring Bar Holder
 ● $\phi 40$ mm
 $\phi 1\ 1/2''$ - 5 SET

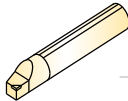

Boring Tool
 $\phi 40$ $\phi 1\ 1/2''$

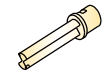

Oil-feed Drill
 $\phi 40$ <math><\phi 1\ 1/2''</math>



Oil-feed Tool Sleeve
 ● $\phi 32$ $\phi 1\ 1/4''$ - 2 PC
 ● $\phi 25$ $\phi 1''$ - 1 PC
 ○ $\phi 20$ $\phi 3/4''$
 ○ $\phi 16$ $\phi 5/8''$

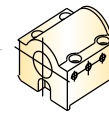

Drill Holder
 ● $\phi 40$ mm
 $\phi 1\ 1/2''$ - 1 SET

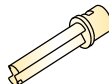

Oil-feed Drill
 $\phi 40$ $\phi 1\ 1/2''$



I.D. and Face Tooling
 12T- $\phi 20$ $3/4''$
 10T- $\phi 25$ $1''$



Tool Clamping Pad
 ● 12T- 2 PC
 ● 10T- 2 PC

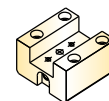

Square Tool Holder
 ● 12T- $\phi 20$ $3/4''$ - 2 SET
 ● 10T- $\phi 25$ $1''$ - 2 SET



O.D. and Face Tooling
 12T- $\phi 20$ $3/4''$
 10T- $\phi 25$ $1''$



Gib
 ● 12T- $\phi 20$ $3/4''$ - 12 SET
 ● 10T- $\phi 25$ $1''$ - 10 SET

Unit: mm inch

● Standard

○ Optional

■ GT-250B

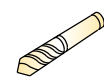
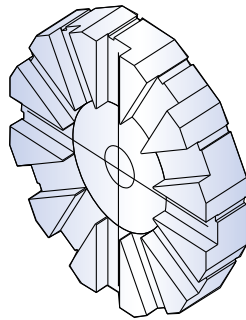

Drill



Drill Socket
● MT1- 1PC
● MT2- 1PC
● MT3- 1PC
○ MT4

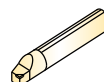

Boring Tool
$\phi 40$ <math><\phi 1\frac{1}{2}"</math>



Boring Bar Sleeve
● $\phi 32$ $\phi 1 \frac{1}{4}"$ - 2 PC
● $\phi 25$ $\phi 1"$ - 2 PC
● $\phi 20$ $\phi 3/4"$ - 1 PC
● $\phi 16$ $\phi 5/8"$ - 1 PC
● $\phi 12$ $\phi 1/2"$ - 1 PC
● $\phi 10$ $\phi 3/8"$ - 1 PC
● $\phi 8$ $\phi 5/16"$ - 1 PC
● $\phi 6$ $\phi 1/4"$ - 1 PC

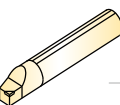

Boring Tool
 $\phi 40$ $\phi 1\frac{1}{2}"$

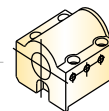

Boring Bar Holder
● $\phi 40$ $\phi 1\frac{1}{2}"$
- 5 SET

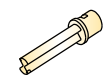

Oil-feed Drill
 $\phi 40$ <math><\phi 1\frac{1}{2}"</math>



Oil-feed Tool Sleeve
● $\phi 32$ $\phi 1 \frac{1}{4}"$ - 1 PC
● $\phi 25$ $\phi 1"$ - 1 PC
○ $\phi 20$ $\phi 3/4"$
○ $\phi 16$ $\phi 5/8"$

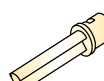

Oil-feed Drill
 $\phi 40$ $\phi 1\frac{1}{2}"$

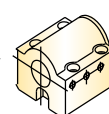

Drill Holder
● $\phi 40$ $\phi 1\frac{1}{2}"$
- 1 SET

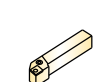

I.D. and Face Tooling
 $\square 25$ $1"$



Gib
● $\square 25$ $1"$ - 2 SET

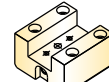

Square Tool Holder
● $\square 25$ $1"$ - 2 SET

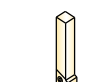

O.D. and Face Tooling
 $\square 25$ $1"$



Gib
● $\square 25$ $1"$ - 12 SET

■ GT-300B/LA

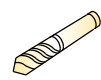
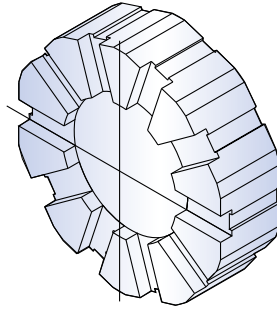

Drill



Drill Socket

- MT2
- MT3-1 PC
- MT4-1 PC

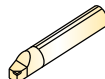

Boring Tool
 ø50 <ø2"



Boring Bar Sleeve

- ø40 ø1 & 1/2" - 2 PC
- ø32 ø1 & 1/4" - 2 PC
- ø25 ø1" - 1 PC
- ø20 ø3/4" - 1 PC
- ø16 ø5/8" - 1 PC
- ø12 ø1/2" - 1 PC
- ø10 ø3/8" - 1 PC
- ø8 ø5/16" - 1 PC

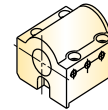

Boring Bar Holder
 ● ø50 ø2" - 5 SET

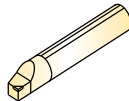

Boring Tool
 ø50 <ø2"

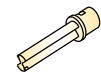

Oil-feed Drill
 ø50 <ø2"



Boring Bar Sleeve

- ø40 ø1 & 1/2" - 1 PC
- ø32 ø1 & 1/4" - 1 PC
- ø25 ø1" - 1 PC
- ø20 ø3/4" - 1 PC
- ø16 ø5/8" - 1 PC

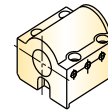

Drill Holder
 ● ø50 ø2" - 1 SET

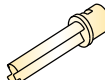

Oil-feed Drill
 ø50 ø2"



I.D. and Face Tooling
 10T- □25 1"
 8T- □32 1 & 1/4"



Gib
 ● 10T-2 SET
 ● 8T-2 SET

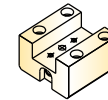

Square Tool Holder
 ● 10T- □25 1" - 2 SET
 ● 8T- □32 1 & 1/4" - 2 SET



Cutting/Grooving Tool
 10T- □25 1"
 8T- □32 1 & 1/4"

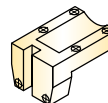

Cutting/Grooving Tool Holder
 ● 10T- □25 1" - 1 SET
 ● 8T- □32 1 & 1/4" - 1 SET



O.D. and Face Tooling
 10T- □25 1"
 8T- □32 1 & 1/4"



Gib
 ● 10T-10 SET
 ● 8T- 8 SET

Unit: mm inch

● Standard

○ Optional

■ GT-200MA

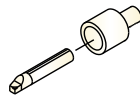
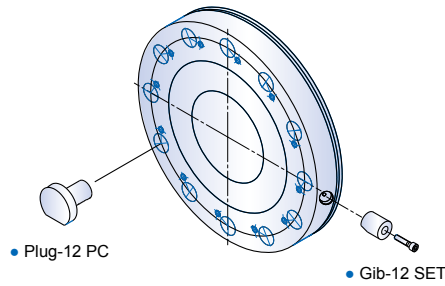

- ø30mm or Less boring bar
- E2 30x 8 5/16"
 - E2 30x10 3/8"
 - E2 30x12 1/2"
 - E2 30x16 5/8"
 - E2 30x20 3/4"
 - E2 30x25 1"
 - E2 30x32 1 1/4"

Boring Holder

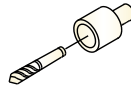

- Drill
- F30- MT1
 - F30- MT2
 - F30- MT3

Drill Holder

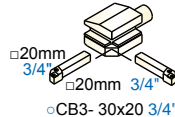

- 20mm 3/4"
- 20mm 3/4"
- CB3- 30x20 3/4"

O.D. & End Tool Holder

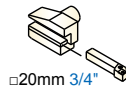

- 20mm 3/4"
- B3- 30x20 3/4"

O.D. Tool Holder

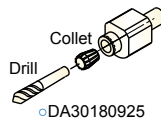

- DA30180925

Axis Milling Tool Holder



- 3-2mm
- 4-3mm
- 5-4mm
- 6-5mm
- 7-6mm
- 8-7mm
- 9-8mm
- 10-9mm
- 11-10mm
- 12-11mm
- 13-12mm
- 14-13mm
- 15-14mm
- 16-15mm

Collet

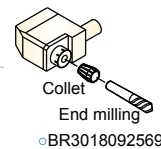

- BR3018092569

Radial Milling Tool Holder



- ET1- ER25(M1)
- ET1- ER25(M2)
- ET1- ER25(M3)
- ET1- ER25(M4)
- ET1- ER25(M5)
- ET1- ER25(M6)
- ET1- ER25(M8)
- ET1- ER25(M10)
- ET1- ER25(M12)

Tapping Sleeve

Unit: mm inch

● Standard

○ Optional

■ GT-250MA, 300MA/LMB

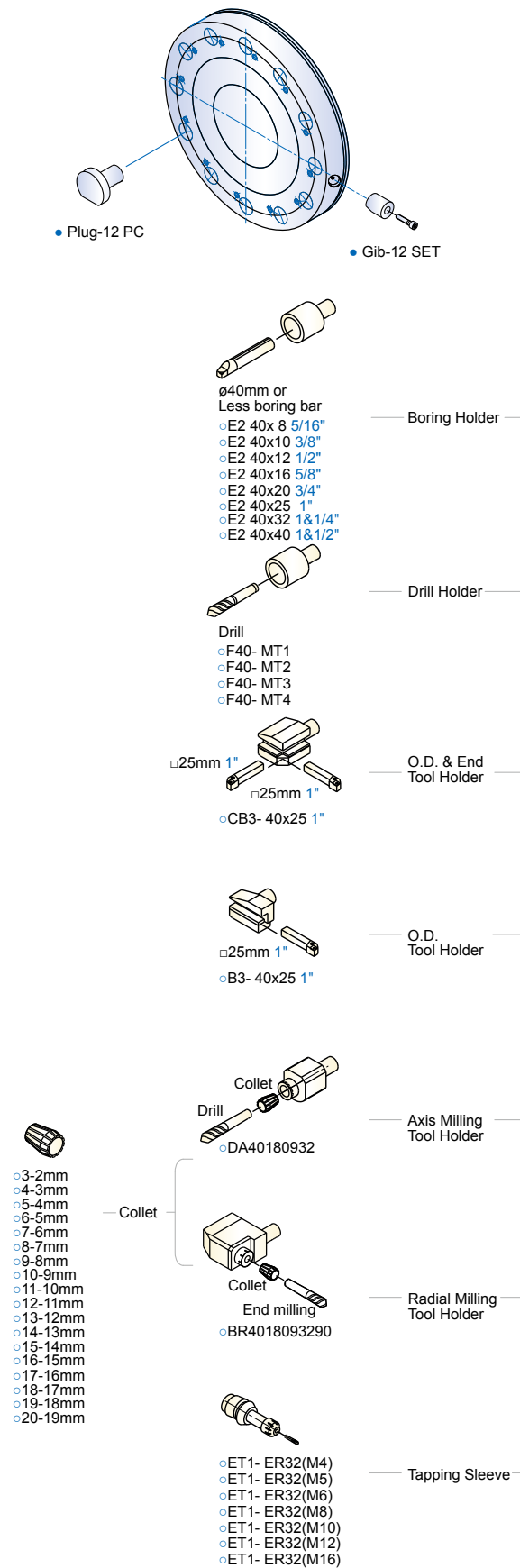



Unit: mm inch

● Standard

○ Optional

TC-16LA/LB

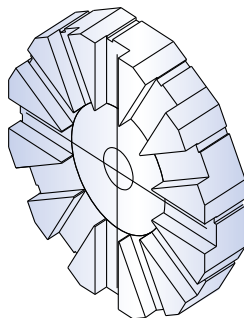

Drill



Drill Socket
● MT1-1PC
● MT2-1PC
● MT3-1PC
○ MT4

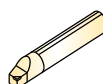

Boring Tool
$\phi 40$ $\phi 1\frac{1}{2}"$



Boring Bar Sleeve
● $\phi 32$ $\phi 1\frac{1}{4}"$ - 2 PC
● $\phi 25$ $\phi 1"$ - 2 PC
● $\phi 20$ $\phi 3/4"$ - 1 PC
● $\phi 16$ $\phi 5/8"$ - 1 PC
● $\phi 12$ $\phi 1/2"$ - 1 PC
● $\phi 10$ $\phi 3/8"$ - 1 PC
● $\phi 8$ $\phi 5/16"$ - 1 PC
● $\phi 6$ $\phi 1/4"$ - 1 PC

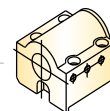

Boring Bar Holder
● $\phi 40$ mm
 $\phi 1\frac{1}{2}"$ - 5 SET

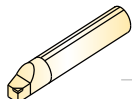

Boring Tool
 $\phi 40$ $\phi 1\frac{1}{2}"$



Oil-feed Drill
$\phi 40$ $\phi 1\frac{1}{2}"$



Oil-feed Tool Sleeve
● $\phi 32$ $\phi 1\frac{1}{4}"$ - 2 PC
● $\phi 25$ $\phi 1"$ - 1 PC
○ $\phi 20$ $\phi 3/4"$
○ $\phi 16$ $\phi 5/8"$

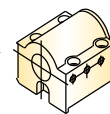

Drill Holder
● $\phi 40$ mm
 $\phi 1\frac{1}{2}"$ - 1 SET

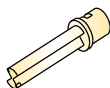

Oil-feed Drill
 $\phi 40$ $\phi 1\frac{1}{2}"$



I.D. and Face Tooling
12T- $\square 20$ $3/4"$
10T- $\square 25$ $1"$



Tool Clamping Pad
● 12T- 2 PC
● 10T- 2 PC

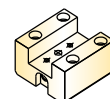

Square Tool Holder
● 12T- $\square 20$ $3/4"$ - 2 SET
● 10T- $\square 25$ $1"$ - 2 SET



O.D. and Face Tooling
12T- $\square 20$ $3/4"$
10T- $\square 25$ $1"$



Gib
● 12T- $\square 20$ $3/4"$ - 12 SET
● 10T- $\square 25$ $1"$ - 10 SET

Unit: mm inch

● Standard

○ Optional

■ TC-26/36



Drill



Drill socket
○ MT1
○ MT2
● MT3-1
○ MT4



Boring Tool
< $\varnothing 40\text{mm}$, < $\varnothing 1\frac{1}{2}''$



Boring bar sleeve
● $\varnothing 32$ $\varnothing 1\frac{1}{4}''$ -2
● $\varnothing 25$ $\varnothing 1''$ -2
● $\varnothing 20$ $\varnothing 3/4''$ -1
● $\varnothing 16$ $\varnothing 5/8''$ -1
● $\varnothing 12$ $\varnothing 1/2''$ -1
● $\varnothing 10$ $\varnothing 3/8''$ -1
● $\varnothing 8$ $\varnothing 5/16''$ -1

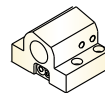

Boring bar holder
12T ● $\varnothing 40\text{mm}$, $\varnothing 1\frac{1}{2}''$ -5

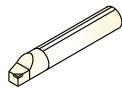

Boring Tool
 $\varnothing 40\text{mm}$, $\varnothing 1\frac{1}{2}''$



Drill



Drill socket
● MT4-1

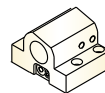

Boring bar holder
12T ● $\varnothing 50\text{mm}$, $\varnothing 2''$ -1

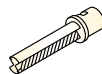

Throw away drill
 $\varnothing 40\text{mm}$, $\varnothing 1\frac{1}{2}''$

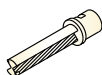

Throw away drill
< $\varnothing 40\text{mm}$, < $\varnothing 1\frac{1}{2}''$



Boring bar sleeve
● $\varnothing 32$ $\varnothing 1\frac{1}{4}''$ -1
● $\varnothing 25$ $\varnothing 1''$ -1
○ $\varnothing 20$ $\varnothing 3/4''$
○ $\varnothing 16$ $\varnothing 5/8''$

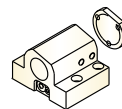

Boring bar holder
12T ● $\varnothing 40\text{mm}$, $\varnothing 1\frac{1}{2}''$ -1



I.D. and Face Tooling
○ $\square 25\text{mm}$ 1"



Gib
● $\square 25\text{mm}$ 1" -2

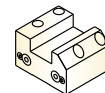

Face and I.D. holder
12T ● $\square 25\text{mm}$, 1" -2



O.D. and Face Tooling
○ $\square 25\text{mm}$ 1"



Gib
● $\square 25\text{mm}$ 1" -12

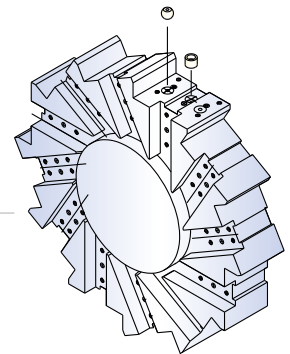

Unit: mm inch
 ● Standard
 ○ Optional

TC-46

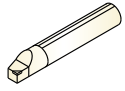

Boring Bar
 ø60mm ø2&1/2"

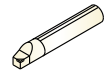

Boring Bar
 < ø50mm ø2"

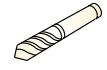

Drill

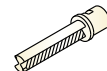

Throw-Away Drill
 ø60mm ø2&1/2"

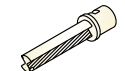

Throw-Away Drill
 < ø50mm ø2"



Face and O.D. Cutting
 □32mm □1&1/4"



Face and O.D. Cutting
 □32mm □1&1/4"



Cutting Off Tool
 □32mm □1&1/4"



Boring Bar Sleeve

- ø50 ø2" -2PC
- ø40 ø1&1/2" -2PC
- ø32 ø1&1/4" -2PC
- ø25 ø1" -1PC
- ø20 ø3/4" -1PC
- ø16 ø5/8" -1PC
- ø12 ø1/2"
- ø10 ø3/8"
- ø8 ø5/16"



Drill Socket

- MT1
- MT2
- MT3
- MT4 -1PC
- MT5



Throw-Away Drill Socket

- ø50 ø2" -1PC
- ø40 ø1&1/2" -2PC
- ø32 ø1&1/4" -2PC
- ø25 ø1"
- ø20 ø3/4"
- ø16 ø5/8"



Gib

- □32 □1&1/4" -2SET



Gib

- □32 □1&1/4" -10SET



Gib

- □32 □1&1/4" -1SET

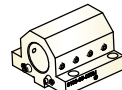

Boring Bar Holder

- ø60 ø2&1/2" -5SET

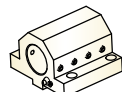

Drill Holder

- ø60 ø2&1/2" -1SET

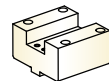

Square Tool Holder

- □32 □1&1/4" -2SET

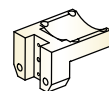

Cutting/Grooving Tool Holder

- □32 □1&1/4" -1SET

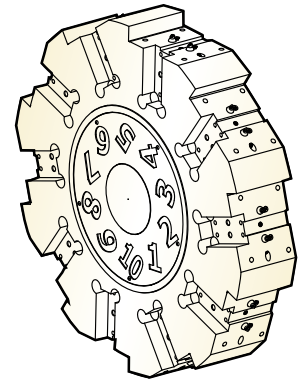

10T

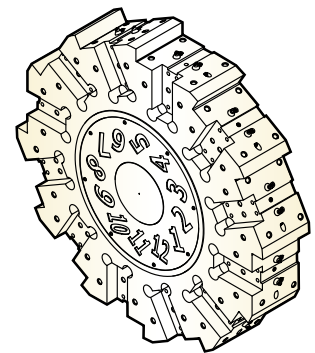

12T

Unit: mm inch

● Standard

○ Optional

TC-46M

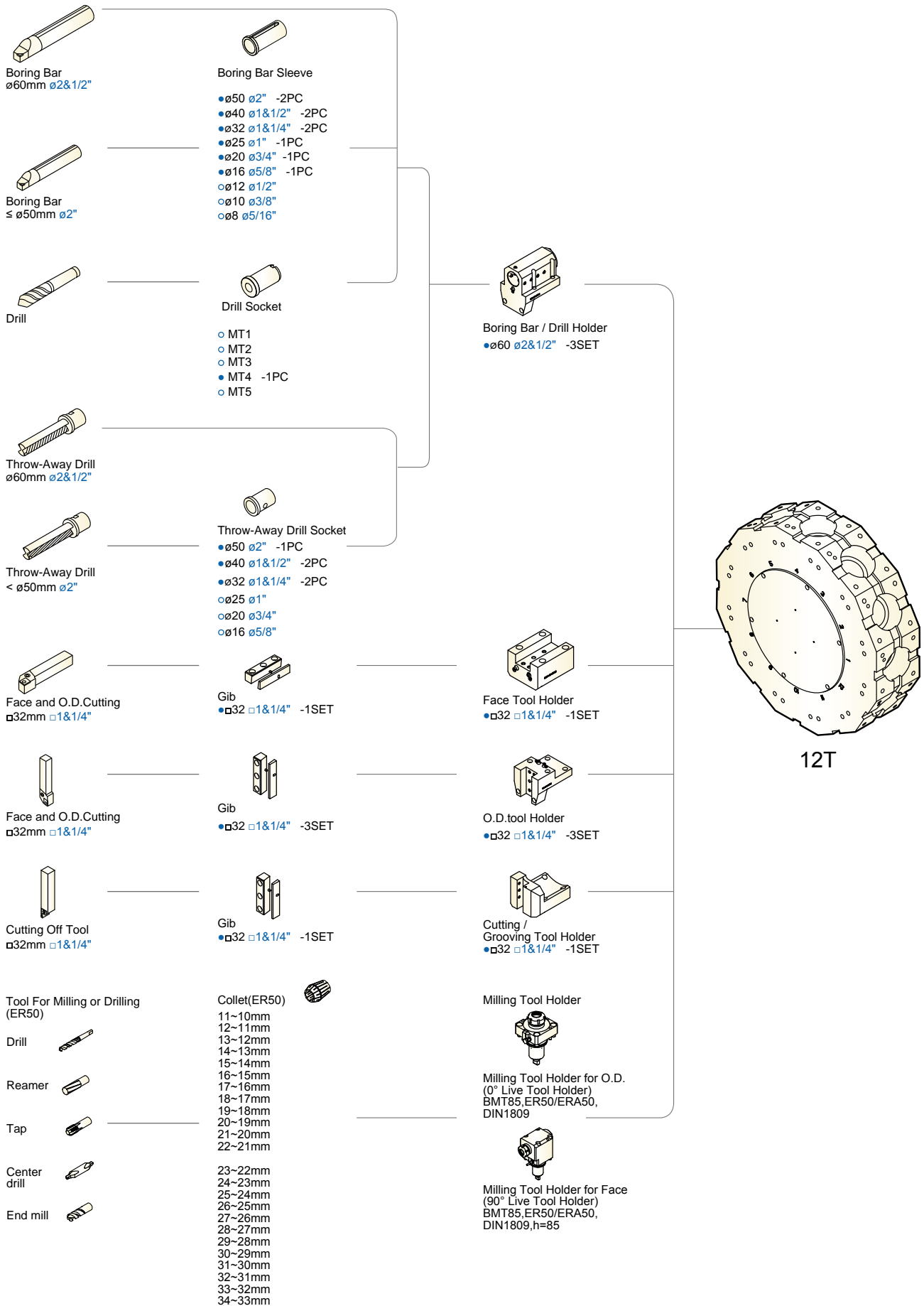

■ NTC-2000LY/LSY

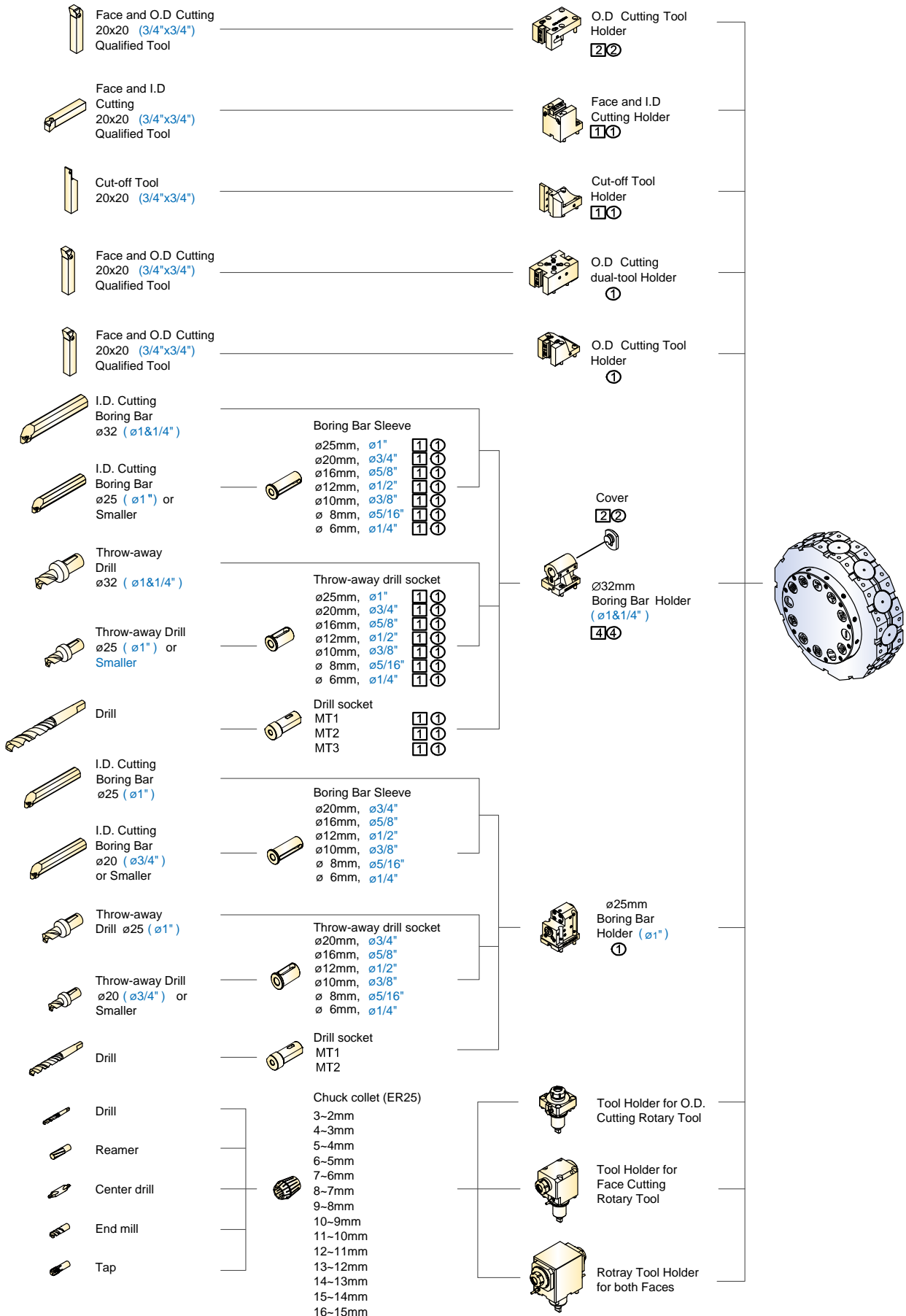

■ NT-2500SY

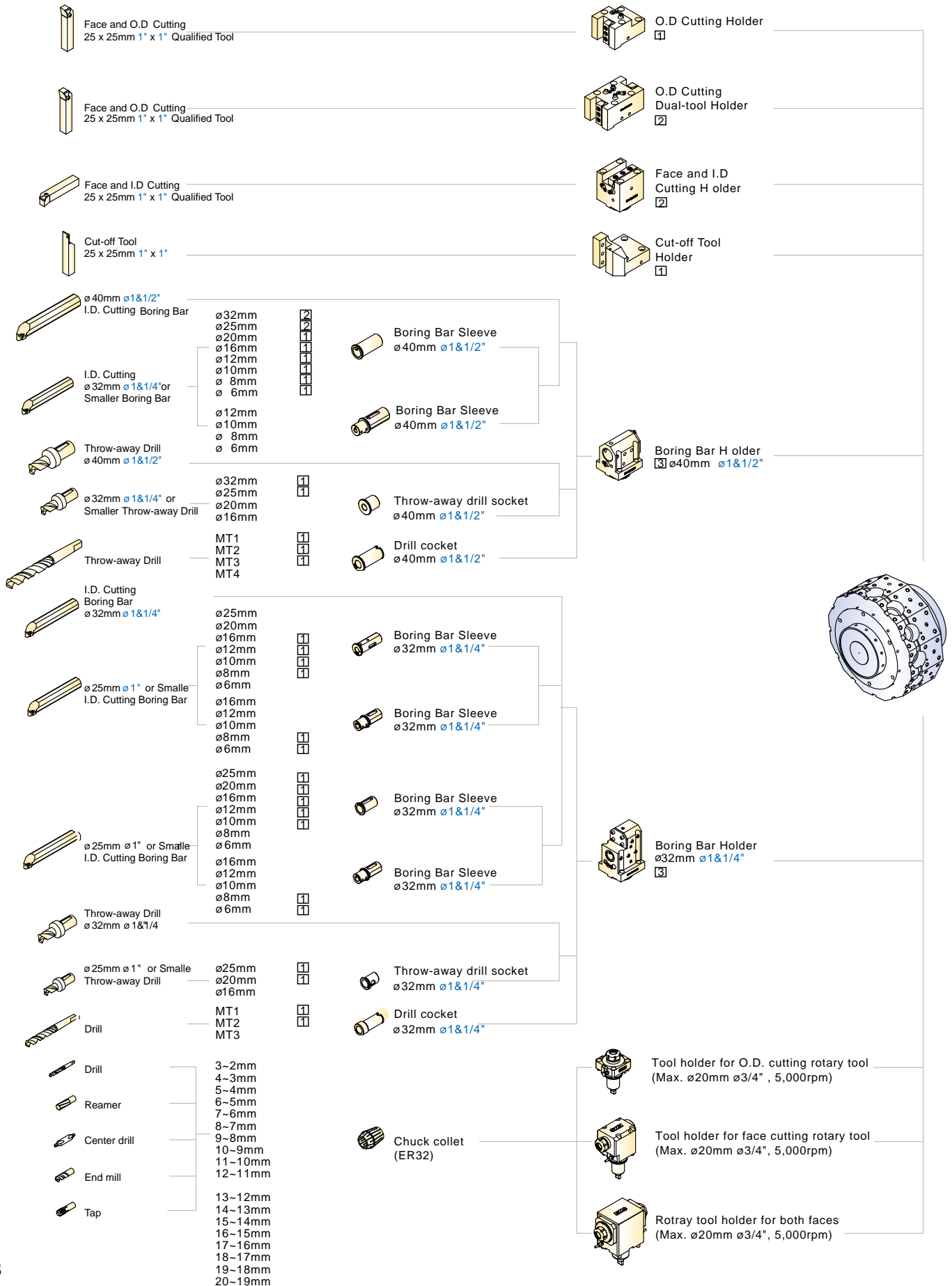

DIMENSIONS

Unit: mm inch

GT

GT-200B/MA, 250B/MA, 300B/MA

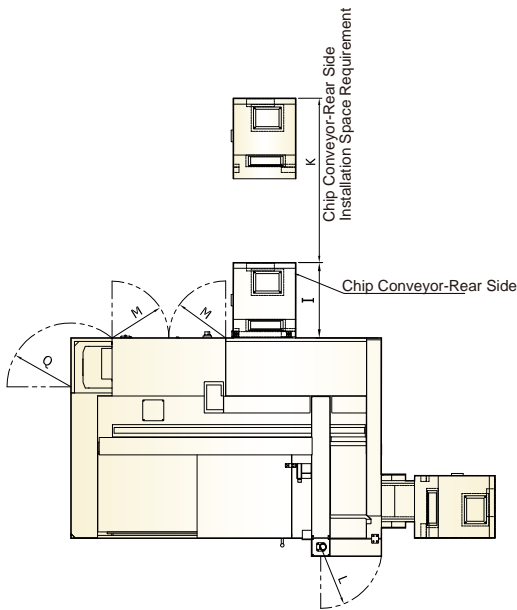

	A	B	C	D	E	F	G	H	I
GT-200B/MA	2,225 87.6"	1,805 71.06"	1,825 71.85"	1,020 40.16"	333 13.11"	1,048 41.26"	1,350 53.15"	974 38.35"	610 24.02"
GT-250B/MA	2,680 105.51"	1,885 74.21"	1,955 76.97"	1,060 41.73"	375 14.76"	1,035 40.75"	1,630 64.17"	980 38.58"	652 25.67"
GT-300B/MA	3,230 127.17"	2,042 80.39"	2,015 79.33"	1,062 41.81"	416 16.38"	1,200 47.24"	1,950 76.77"	973 38.31"	638 25.12"

	J	K	L	M	N	O	P	Q
GT-200B/MA	954 37.56"	1,630 64.17"	540 21.26"	410 16.14"	580 22.83"	-	2,250 88.58"	-
GT-250B/MA	960 37.8"	1,150 45.28"	530 20.87"	490 19.29"	735 28.94"	-	2,300 90.55"	550 21.65"
GT-300B/MA	959 37.76"	1,850 72.83"	575 22.64"	490 19.29"	875 34.45"	-	2,427 95.55"	-

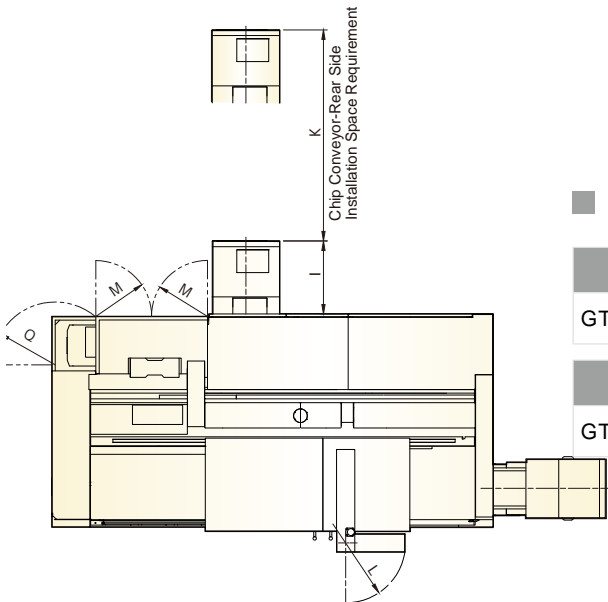
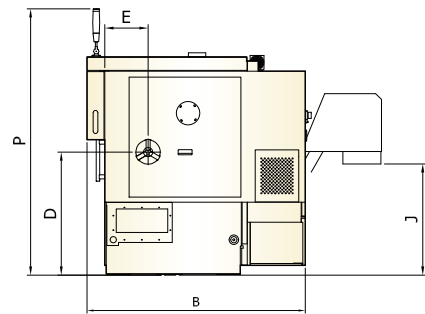
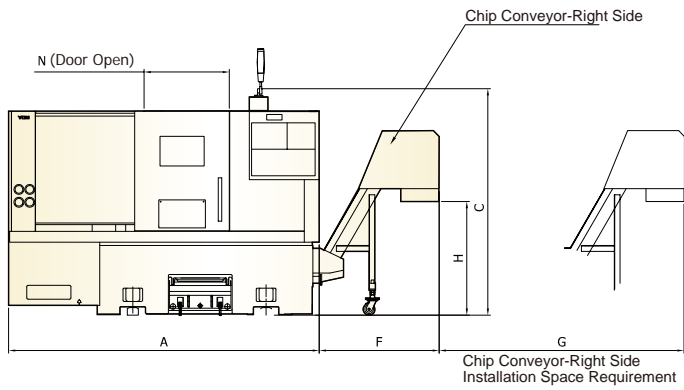

GT-300LMB

	A	B	C	D	E	F	G	H	I
GT-300LMB	3,870 121.54"	2,047 80.59"	2,015 79.33"	1,062 41.81"	416 16.38"	978 38.5"	2,320 91.34"	973 38.31"	638 25.12"

	J	K	L	M	N	O	P	Q
GT-300LMB	959 37.76"	1,850 72.83"	575 22.64"	490 19.29"	875 34.45"	450 17.72"	2,427 95.55"	-

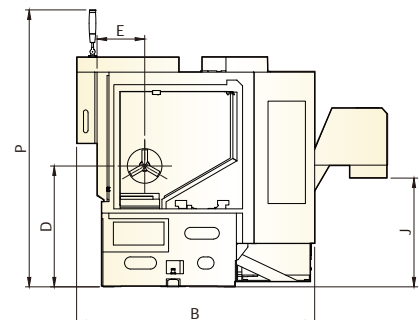
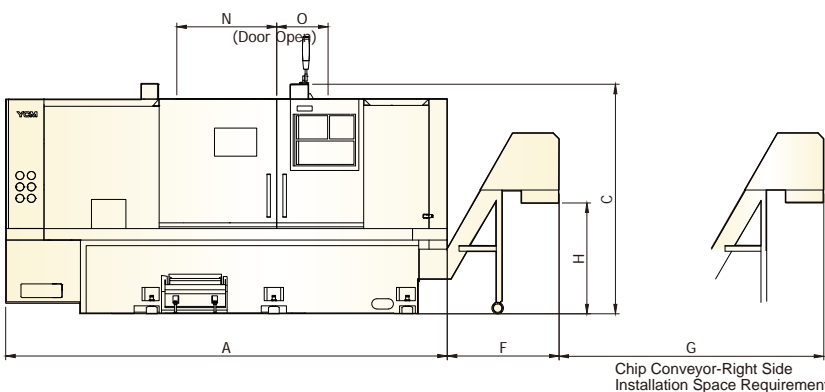

TC

Unit: mm inch

TC-16LA/LB

		A	B	C	D	E
TC-16 LA/LB	Right Side Chip Conveyor	2,771 109.09"	1,230 48.43"	2,485 97.83"	310 12.20"	1,795 70.67"
	Rear Side Chip Conveyor	2,811 110.67"	-	2,525 99.41"	-	1,827 71.93"

		F	G	H	I	J
TC-16 LA/LB	Right Side Chip Conveyor	1,799 70.83"	1,554 61.18"	642 25.28"	620 23.70"	980 38.58"
	Rear Side Chip Conveyor	1,831 72.09"	1,554 61.18"	642 25.28"	620 23.70"	1,020 40.16"

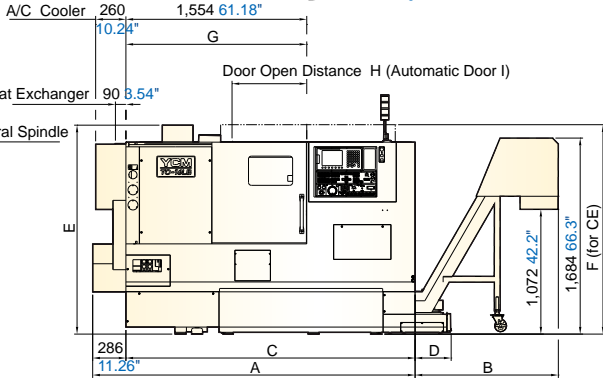
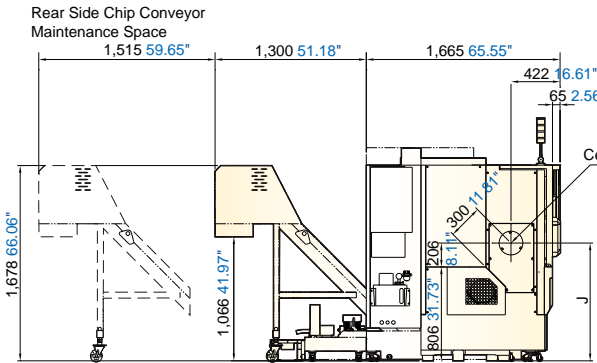
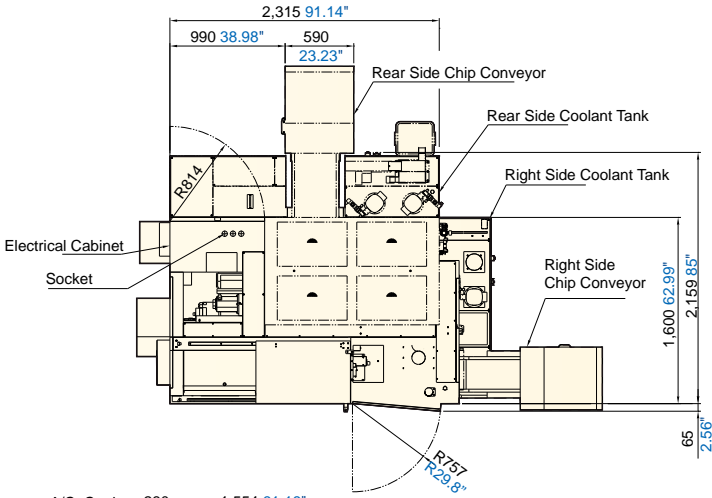

TC-26, 36

	A	B	C	D	E
TC-26	3,250 127.95"	1,786 70.31"	1,841 72.48"	730 28.74"	859 33.82"
TC-36	3,936 154.96"	2,093 82.40"	2,011 79.17"	760 29.92"	876 34.49"

	F	G	H (2nd Door)	I	J
TC-26	1,010 39.76"	1,060 41.73"	-	185 7.28"	575 22.64"
TC-36	1,095 43.11"	1,060 41.73"	840 33.07"	206 8.11"	572 22.52"

	K	M	N	P
TC-26	654 25.75"	1,090 42.91"	900 35.43"	365 14.37"
TC-36	663 26.10"	1,117 43.98"	960 37.8"	435 17.13"

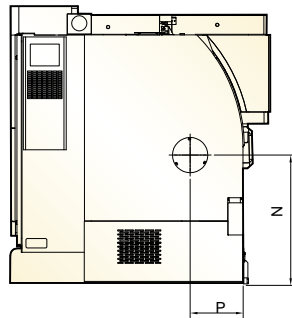
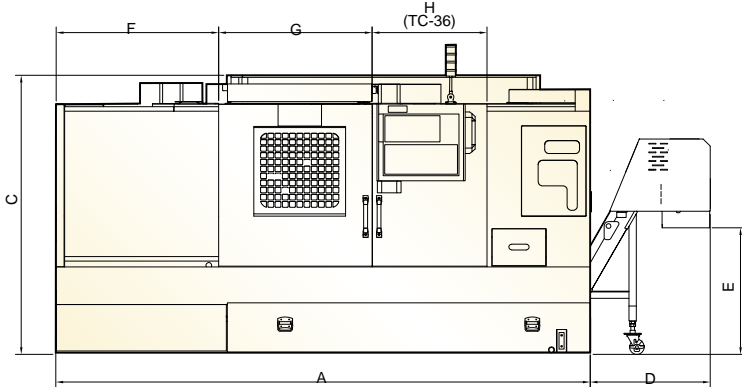
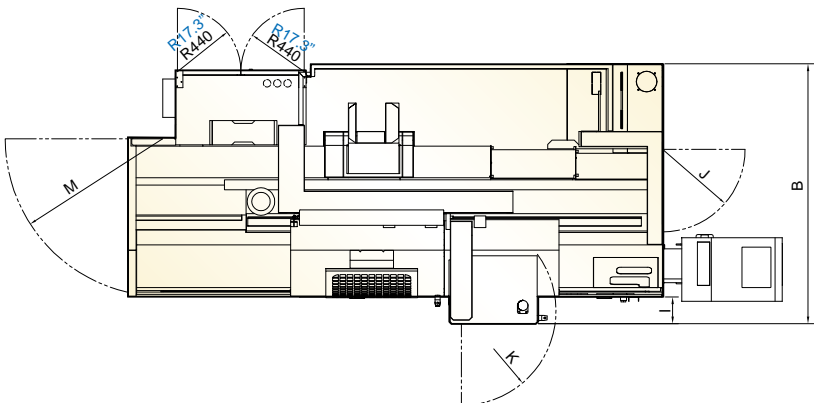

TC-46/1000 /1650 /2300

	A	B	C	D
TC-46 /1000	-	5,764 226.93"	5,066 199.45"	1,670 65.75"
TC-46 /1650	-	6,327 249.09"	5,716 225.04"	1,560 61.42"
TC-46 /2300	-	7,380 290.55"	6,634 261.18"	1,560 61.42"

	E	F	G	H
TC-46 /1000	1,250 49.21"	838 32.99"	535 21.06"	4,370 172.5"
TC-46 /1650	2,500 98.43"	1,030 40.55"	810 31.89"	5,020 197.64"
TC-46 /2300	3,750 147.64"	1,030 40.55"	1,432 56.38"	5,935 233.66"

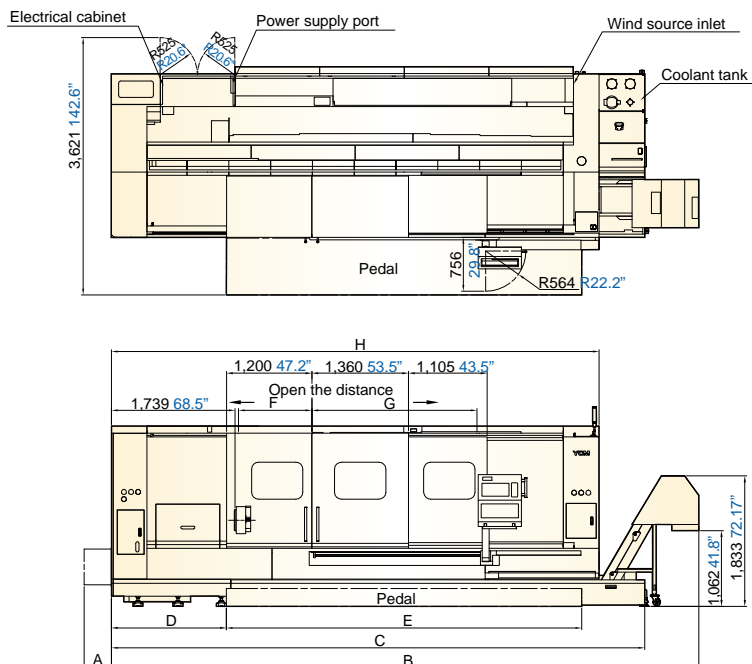
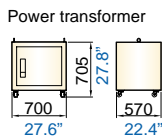
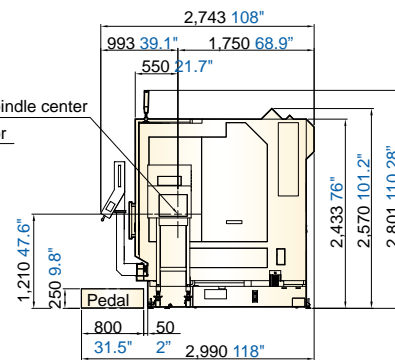
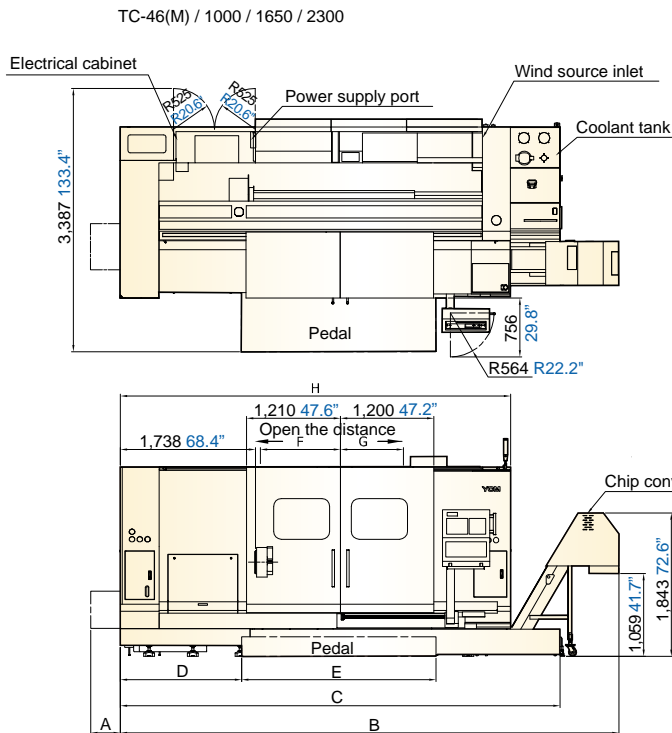

TC-46/3200, 46M/3200

	A	B	C	D
TC-46 /3200	-	8,265 325.39"	7,505 295.47"	1,620 63.78"
TC-46M /3200	380 14.96"			

	E	F	G	H
TC-46 /3200	5,000 196.85"	1,030 40.55"	2,325 91.54"	6,860 270.08"
TC-46M /3200				

Machine dimensions of TC-46/46M. Big Bore are identical with TC-46M of above list.

NTC

Unit: mm inch

NTC-2000LY/LSY

	A	B	C	D
NTC-2000LY	4,261	3,800	2,770	1,919
NTC-2000LSY	167.76"	149.61"	109.06"	75.55"

	E	F	G	H	J
NTC-2000LY	591	412	1,745	1,918	4,104
NTC-2000LSY	23.27"	16.22"	68.7"	75.51"	161.57"

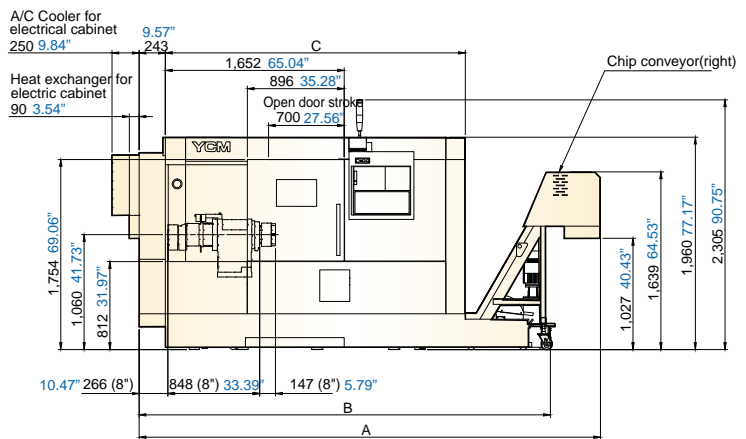
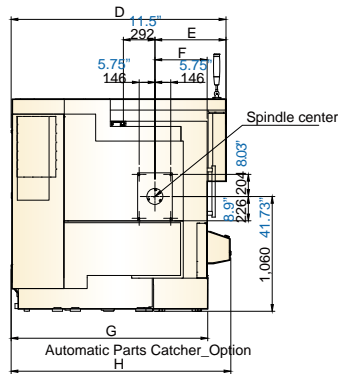
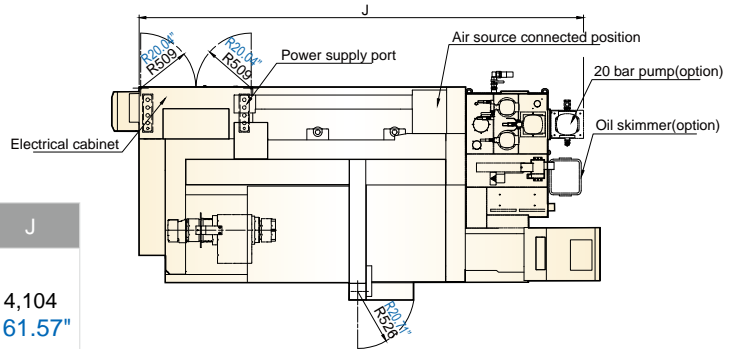

NT

NT-2500SY

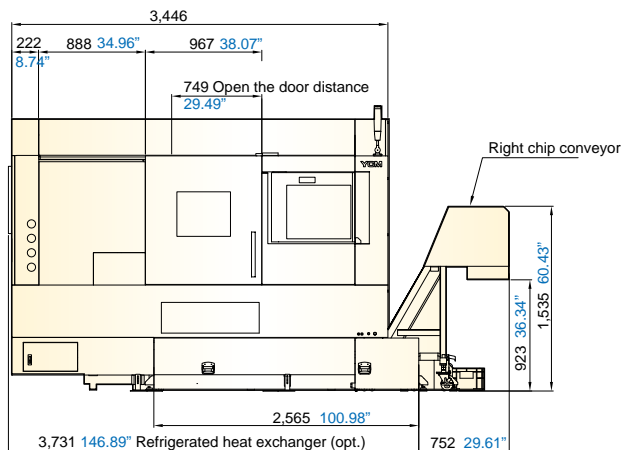
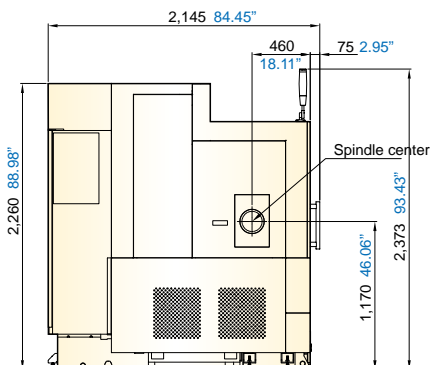
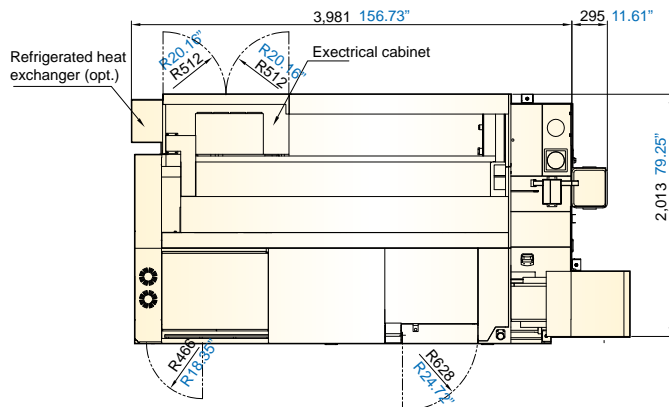

SPECIFICATIONS

GT

ITEMS		GT				
		200MA	200B	250MA	250B	
MACHINING CAPACITY						
Swing Over Bed	mm inch	ø500 ø19.69"	ø500 ø19.69"	ø550 ø21.65"	ø550 ø21.65"	
Swing Over Carriage	mm inch	ø330 ø12.99"	ø330 ø12.99"	ø420 ø16.54"	ø420 ø16.54"	
Max. Turning Diameter	mm inch	ø230 ø9.06"	ø260 (ø200*) ø10.24" (ø7.87" *)	ø270 ø10.63"	ø350 (ø270*1) ø13.78" (ø10.63" *1)	
Max. Turning Length	mm inch	370 ø14.57"	345 (325*) 13.58" (12.8" *)	560 22.05"	515 (530*1) 20.28" (20.87" *1)	
SPINDLE						
Chuck Size		6"	8"	8"	10"	
Spindle Nose		A2-5	A2-6	A2-6	A2-8	
Spindle Front Bearing Inner Diameter	mm inch	ø90 ø3.54"	ø100 ø3.94"	ø110 ø4.33"	ø130 ø5.12"	
Hole Through Spindle	mm inch	ø56 ø2.2"	ø62 ø2.44"	ø62 (ø77*2) ø2.44" (ø3.03" *2)	ø88 ø3.46"	
Hole Through Draw Tube	mm inch	ø45 ø1.77"	ø52 ø2.05"	ø52 (ø66*2) ø2.05" (ø2.6" *2)	ø75 ø2.95"	
Spindle Speed	rpm	6,000	4,500	4,500	3,500	
Max. Spindle Torque	kgf-m lb-ft	14.61 105.68	19.5 141.05	51.6 373.23	58.9 426.03	
C-axis Speed		50	-	50	-	
C-axis Index	deg	0.001°	-	0.001°	-	
MOTOR						
Main Spindle Motor	kW HP	(L) 3.7 / 7.5 (H) 5.5 / 7.5 / 9 / 11 (L) 5 / 10 (H) 7 / 10 / 12 / 15 (L) cont. / 15min. (H) cont. / 30min. / 15min. / 1min.		(L) 7.5 / 15 (H) 11 / 15 (L) 10 / 20 (H) 15 / 20 (L) cont. / 15min. (H) cont. / 30min.		
Axial Motor (X/Z) (cont.)	kW HP	2.5 / 3 3.35 / 4.02	2.5 / 3 3.35 / 4.02	2.5 / 2.5 3.35 / 3.35	2.5 / 2.5 3.35 / 3.35	
Turret Motor (cont.)	kW HP	0.75 1.01	1.2 1.6	1.2 1.6	1.2 1.6	
Live Tool Motor	kW HP	1.1 / 3.7 1.48 / 4.96 (cont. / 30min.)	-	3.7 / 5.5 4.96 / 7.38 (cont. / 30min.)	-	
Live Tool Motor Speed	rpm	4,500	-	3,000	-	
TRAVEL						
X-axis Travel	mm inch	177 6.97"	150 (170*) 5.91" (6.69" *)	230 9.06"	195 (230*1) 7.68" (9.06" *1)	
Z-axis Travel	mm inch	370 14.57"	345 (325*) 13.58" (12.8" *)	560 22.05"	515 (530*1) 20.28" (20.87" *1)	
Rapid Feedrate (X/Z)	m/min ipm	24 / 30 945 / 1,181	24 / 30 945 / 1,181	20 / 24 787 / 945	20 / 24 787 / 945	
Cutting Feedrate (X/Z)	mm/min ipm	1~10,000 0.04~394				
TURRET						
Turret Type		Servo Motor Drive (Hydraulic Clamp)				
Tool Stations	Std. Tool	T	-	10 (12)	-	10 (12)
	VDI	T	12*	12*	12*1	12*1
Tool Type	Shank Height for Square Tool	mm inch	□20 □3/4"	□25 □1"	□25 □1"	□25 □1"
	Shank Diameter for Boring Bar	mm inch	ø32 ø1&1/4"	ø40 ø1&1/2"	ø40 ø1&1/2"	ø40 ø1&1/2"
TAILSTOCK						
Tailstock Quill Diameter	mm inch	ø75 ø2.95"	ø75 ø2.95"	ø100 ø3.94"	ø100 ø3.94"	
Tailstock Quill Taper	Stationary Center (std.)		MT-4	MT-4	MT-5	MT-5
	Live Center (opt.)		-	-	MT-4	MT-4
Tailstock Quill Travel	mm inch	100 3.94"	100 3.94"	100 3.94"	100 3.94"	
Tailstock Stroke	mm inch	260 10.24"	260 10.24"	440 17.32"	415 (400*1) 16.34" (15.75" *1)	
HYDRAULIC SYSTEM						
Pressure	kgf/cm ² psi	45 640				
Flow Rate	L/min gpm	50Hz : 23 6.08 60Hz : 27.5 7.27				
COOLANT						
Tank Capacity	L gal	100 26.42	100 26.42	130 34.35	130 34.35	
Pump Motor	kW HP	0.7 0.94				
GENERAL						
Machine Weight	kg lb	4,260 9,392	4,210 9,281	6,000 13,228	6,200 13,669	

Above specifications may vary depending on the machine and the surrounding environment. The manufacturer reserves the right to modify the design, specifications, mechanisms, etc., to improve the performance of the machine without notice. The test data provided in this catalog is performed under specific test procedures and environmental conditions. Remark*: stands for VDI30 type. Remark*1: stands for VDI40 type. Remark*2: stands for big bore type.

SPECIFICATIONS

ITEMS	GT		
	300MA	300B	300LMB
MACHINING CAPACITY			
Swing Over Bed	mm inch	ø600 ø23.62"	
Swing Over Carriage	mm inch	ø450 ø17.72"	
Max. Turning Diameter	mm inch	ø360 ø14.17"	ø440(ø360*1) ø17.32"(ø14.17" *1)
Max. Turning Length	mm inch	742 29.21"	700(730 *1) 27.56"(28.74" *1)
SPINDLE			
Chuck Size		10"	12"
Spindle Nose		A2-8	A2-8
Spindle Front Bearing Inner Diameter	mm inch	ø130 ø5.12"	ø160 ø6.3"
Hole Through Spindle	mm inch	ø88 ø3.46"	ø105 ø4.13"
Hole Through Draw Tube	mm inch	ø75 ø2.95"	ø91 ø3.58"
Spindle Speed	rpm	3,500	3,000
Max. Spindle Torque	kgf-m lb-ft	77.3 559.12	90 650.98
C-axis Speed	rpm	50	-
C-axis Index	deg	0.001°	-
MOTOR			
Spindle Motor	kW HP	(L) 11 / 18.5 (H) 15 / 18.5 (L) 15 / 25 (H) 20 / 25 (L) cont. / 15min. (H) cont. / 30min.	
Axial Motor (X/Z) (cont.)	kW HP	2.5 / 2.5 3.35 / 3.35	2.5 / 2.5 3.35 / 3.35
Turret Motor (cont.)	kW HP	1.2 1.6	1.2 1.6
Live Tool Motor	kW HP	3.7 / 5.5 4.96 / 7.38 (cont. / 30min.)	-
Live Tool Motor Speed	rpm	3,000	-
TRAVEL			
X-axis Travel	mm inch	275 10.83"	245 (275*) 9.65" (10.83" *)
Z-axis Travel	mm inch	742 29.21"	700 (730*) 27.56" (28.74" *)
Rapid Feedrate (X/Z)	m/min ipm	20 / 24 787 / 945	
Cutting Feedrate (X/Z)	mm/min ipm	1~10,000 0.04~394	
TURRET			
Turret Type		Servo Motor Drive (Hydraulic Clamp)	
Tool Stations	Std. Tool	T	-
	VDI	T	8 (10)
Tool Type	Shank Height for Square Tool	mm inch	ø25 ø1"
	Shank Diameter for Boring Bar	mm inch	ø32 (ø25*1) ø1&1/4" (ø1" *)
			ø40 ø1&1/2"
TAILSTOCK			
Tailstock Quill Diameter	mm inch	ø100 ø3.94"	
Tailstock Quill Taper	Stationary Center (std.)	MT-5	
	Live Center (opt.)	MT-4	
Tailstock Quill Travel	mm inch	100 ø3.94"	
Tailstock Stroke	mm inch	605 23.82"	605 23.82"
HYDRAULIC SYSTEM			
Pressure	kgf/cm ² psi	45 640	
Flow Rate	L/min gpm	50Hz : 23 6.08 60Hz : 27.5 7.27	
COOLANT			
Tank Capacity	L gal	150 39.63	
Pump Motor	kW HP	0.7 0.94	
GENERAL			
Machine Weight	kg lb	6,950 15,322	6,950 15,322
			7,850 17,306

Above specifications may vary depending on the machine and the surrounding environment. The manufacturer reserves the right to modify the design, specifications, mechanisms, etc., to improve the performance of the machine without notice. The test data provided in this catalog is performed under specific test procedures and environmental conditions. Remark*: stands for VDI30 type. Remark*1: stands for VDI40 type. Remark*2: stands for big bore type.

ITEMS	TC					
			16LA	16LB	26	36
MACHINING CAPACITY						
Swing Over Bed	mm inch		ø550 ø21.65"	ø550 ø21.65"	ø500 ø19.69"	ø690 ø27.17"
Swing Over Carriage	mm inch		ø320 ø12.60"	ø320 ø12.60"	ø350 ø13.78"	ø510 ø20.08"
Max. Turning Diameter	mm inch		ø260 (ø200*) ø10.24"(ø7.87")	ø260 (ø200*) ø10.24"(ø7.87")	ø470 (ø374* ¹) ø18.50"(ø14.72** ¹)	ø590 (ø494* ¹) ø23.23"(ø19.45** ¹)
Max. Turning Length	mm inch		600 (575*) 23.62"(22.64**)	600 (575*) 23.62"(22.64**)	647 (638) 617* ¹ (608* ¹) 25.47"(25.12") 24.29** ¹ (23.94** ¹)	1,189 (1,159* ¹) 46.81" (45.63** ¹)
SPINDLE						
Chuck Size			6"	8"	10" (12")	12"
Spindle Nose			A2-5	A2-6	A2-8	A2-8
Spindle Front Bearing Inner Diameter	mm inch		ø100 ø3.94"	ø110 ø4.33"	ø120 ø4.72"	ø150 ø5.91"
Hole Through Spindle	mm inch		ø62 ø2.44"	ø77 ø3.03"	ø88 ø3.46"	ø105 ø4.13"
Hole Through Draw Tube	mm inch		ø52 ø2.05"	ø66 ø2.60"	ø78 ø3.07"	ø93 ø3.66"
Spindle Speed	rpm		5,000	4,500	4,000 (2,500 : 2-speed Gear Box)	2,500 : 2-speed Gear Box
Max. Spindle Torque	kgf-m lb-ft		15.58 112.69	17.31 125.21	74.5 538.87	140 1012.64
C-axis Speed	rpm		-	-	-	-
C-axis Index	deg		-	-	-	-
MOTOR						
Main Spindle Motor	kW HP		11 / 15 14.75 / 20.12 (cont. / 15min.)	11 / 15 14.75 / 20.12 (cont. / 15min.)	11 / 15 14.75 / 20.12 (cont. / 30min.)	22 / 26 30 / 35 (cont. / 30min.)
Axial Motor (X/Z) (cont.)	kW HP		1.8 / 1.8 2.41 / 2.41	1.8 / 1.8 2.41 / 2.41	2.5 / 2.5 3.35 / 3.35	2.5 / 2.5 3.35 / 3.35
Turret Motor (cont.)	kW HP		1.2 1.61	1.2 1.61	-	-
Live Tool Motor	kW HP		-	-	-	-
Live Tool Motor Speed	rpm		-	-	-	-
TRAVEL						
X-axis Travel	mm inch		150 (170*) 5.91" (6.69**)	150 (170*) 5.91" (6.69**)	250 9.84"	310 12.20"
Z-axis Travel	mm inch		600 (575*) 23.62" (22.64**)	600 (575*) 23.62" (22.64**)	700 (670* ¹) 27.56" (26.38** ¹)	1,250 (1,230* ¹) 49.21" (48.43** ¹)
Rapid Feedrate (X/Z)	m/min ipm		24 / 30 944.88 / 1181.10	24 / 30 944.88 / 1181.10	15 / 20 91 / 787	15 / 20 91 / 787
Cutting Feedrate (X/Z)	mm/min ipm		1~10,000 0.04~393.70	1~10,000 0.04~393.70	1~5,000 0.04~197	1~5,000 0.04~197
TURRET						
Turret Type			Servo Motor Drive (Hydraulic Clamp)	Servo Motor Drive (Hydraulic Clamp)	Hydraulic Turret (Hydraulic Clamp)	Hydraulic Turret (Hydraulic Clamp)
Tool Stations	Std. Tool	T	12 (10)	10 (12)	12 (10 / 8)	12 (10 / 8)
	VDI	T	12*	12*	10 / 12* ¹	10 / 12* ¹
	BMT	T	-	-	-	-
Tool Type	Shank Height for Square Tool	mm inch	□20 □3/4"	□25 □1"	□25 (□32) 1" (□1&1/4")	□25 (□32) 1" (□1&1/4")
	Shank Diameter for Boring Bar	mm inch	ø40 (ø32*) ø1&1/2" (ø1&1/4** ¹)	ø40 (ø32*) ø1&1/2" (ø1&1/4** ¹)	ø40 / ø50 ø1&1/2" / ø2"	ø40 / ø50 ø1&1/2" / ø2"
TAILSTOCK						
Tailstock Quill Diameter	mm inch		ø75 ø2.95"	ø75 ø2.95"	ø100 ø3.94"	ø100 ø3.94"
Tailstock Quill Taper	Stationary Center (std.)		MT-4	MT-4	MT-5 (Stationary Type)	-
	Live Center (opt.)		-	-	MT-4 (Live Type)	MT-4(Live Type)
Tailstock Quill Travel	mm inch		100 3.94"	100 3.94"	120 4.72"	120 4.72"
Tailstock Stroke	mm inch		500 19.69"	500 19.69"	530 20.87"	1,080 42.52"
HYDRAULIC SYSTEM						
Pressure	kgf/cm ² psi		45 640.04	45 640.04	70 995.6	70 995.6
Flow Rate	L/min gpm		50Hz : 23 6.08 60Hz : 27.5 7.27	50Hz : 23 6.08 60Hz : 27.5 7.27	50Hz : 25 6.61 60Hz : 30 7.93	50Hz : 25 6.61 60Hz : 30 7.93
COOLANT						
Tank Capacity	L gal		165 43.59	165 43.59	139 36.72	200 52.84
Pump Motor	kW HP		0.75 1.01	0.75 1.01	0.59 0.79	0.59 0.79
GENERAL						
Machine Weight	kg lb		3,700 8,157	3,700 8,157	4,400 9,700	7,000 15,432

Above specifications may vary depending on the machine and the surrounding environment. The manufacturer reserves the right to modify the design, specifications, mechanisms, etc., to improve the performance of the machine without notice. The test data provided in this catalog is performed under specific test procedures and environmental conditions. Remark*: stands for VDI30 type. Remark*1: stands for VDI40 type.

ITEMS	TC						
	46/1000	46/1650	46/2300	46/3200	46M/3200		
MACHINING CAPACITY							
Swing Over Bed	mm inch	ø850 ø33.5"					
Swing Over Carriage	mm inch	ø720 ø28.4"					
Max. Turning Diameter	mm inch	ø750 ø29.5"	ø750 ø29.5"	ø750 ø29.5"	ø750 ø29.5"	ø730 ø28.7"	
Max. Turning Length	mm inch	1,000 39.4"	1,650 65"	2,300 90.6"	3,200 126"	3,111 122.5"	
MAIN SPINDLE							
Chuck Size		Standard: 15" (18"/ 21")		Big Bore (opt.)*1: 18" (21"/ 24")			
Spindle Nose		Standard: A2-11		Big Bore (opt.)*1: A2-15			
Spindle Front Bearing Inner Diameter	mm inch	Standard: ø180 ø7.1"		Big Bore (opt.)*1: ø240 ø9.45"			
Hole Through Spindle	mm inch	Standard: ø130 ø5.1"		Big Bore (opt.)*1: ø182 ø7.17"			
Hole Through Draw Tube	mm inch	Standard: ø117 ø4.6"		Big Bore (opt.)*1: ø165			
Spindle Speed	rpm	Standard: 2,000 rpm (15"/ 18"), 1,700 rpm (21")			Big Bore (opt.)*1: 1,200 rpm		
Max. Spindle Torque	kgf-m lb-ft	510 (380*1) 3,688.9 (2,748.6*1)	510 (380*1) 3,688.9 (2,748.6*1)	510 (380*1) 3,688.9 (2,748.6*1)	510 (380*1) 3,688.9 (2,748.6*1)	380 2,749	
C-axis Speed	rpm	-	-	-	-	50	
C-axis Index	deg	-	-	-	-	0.001°	
MOTOR							
Main Spindle Motor	kW HP	30 / 37 40.2 / 49.6 (cont. / 30min.)					
Axial Motor (X/Z) (cont.)	kW HP	4 / 7 5.4 / 9.4					
Turret Motor (cont.)	kW HP	1.8 2.4	1.8 2.4	1.8 2.4	1.8 2.4	4.8 6.44	
Live Tool Motor	kW HP	-	-	-	-	15 / 18.5 / 22 20 / 25 / 30 (cont. / 30min. / 15min.)	
Live Tool Motor Speed	rpm	-	-	-	-	3,000	
TRAVEL							
X-axis Travel	mm inch	405 15.94"	405 15.94"	405 15.94"	405 15.94"	415 16.34"	
Z-axis Travel	mm inch	1,000 39.4"	1,650 65"	2,300 90.6"	3,200 126"	3,200 126"	
Rapid Feedrate (X/Z)	m/min ipm	16 / 18 629.9 / 708.7	16 / 18 629.9 / 708.7	16 / 15 629.9 / 472.4	16 / 12 629.9 / 472.4	16 / 12 629.9 / 472.4	
Cutting Feedrate (X/Z)	mm/min ipm	1~10,000 0.04~393.7					
TURRET							
Turret Type		Servo Motor Drive (Hydraulic Clamp)	Servo Motor Drive (Hydraulic Clamp)	Servo Motor Drive (Hydraulic Clamp)	Servo Motor Drive (Hydraulic Clamp)	Radial Multitasking Turret (Servo Rotating / Hydraulic Clamp)	
Tool Stations	Std. Tool	T	10 (12)	10 (12)	10 (12)	10 (12)	12
	VDI	T	-	-	-	-	-
	BMT	T	-	-	-	-	12 (BMT 85)
Tool Type	Shank Height for Square Tool	mm inch	□32 (□1&1/4")				
	Shank Diameter for Boring Bar	mm inch	ø60 (ø2&1/2")				
TAILSTOCK							
Tailstock Quill Diameter	mm inch	ø150 ø5.9"					
Tailstock Quill Taper	Stationary Center (std.)		MT-5				
	Live Center (opt.)		MT-5				
Tailstock Quill Travel	mm inch	150 5.9"					
Tailstock Stroke	mm inch	825 32.5"	1,475 58.1"	2,125 83.7"	3,025 119.1"	3,015 118.7"	
HYDRAULIC SYSTEM							
Pressure	kgf/cm ² psi	50 711.15					
Flow Rate	L/min gpm	50Hz : 32.5 8.59 60Hz : 38.5 10.17					
COOLANT							
Tank Capacity	L gal	465 122.85	540 142.67	700 184.94	1060 280.05	1060 280.05	
Pump Motor	kW HP	1.51 2.02 (MTH4-40/4)					
GENERAL							
Machine Weight	kg lb	12,500 27,558	13,500 29,762	14,300 31,526	15,500 34,171	15,500 34,171	

Above specifications may vary depending on the machine and the surrounding environment. The manufacturer reserves the right to modify the design, specifications, mechanisms, etc., to improve the performance of the machine without notice. The test data provided in this catalog is performed under specific test procedures and environmental conditions.
 Remark*1: TC-46 Big bore series: Head drive structure is identical with TC-46M, plugged with 2 speed gear box.
 Remark*2: Max. chuck size is up to 24"; standard size: 15"; big bore: 18". Please refer to the travel diagram.

NTC

ITEMS		NTC	
		2000LY	2000LSY
MACHINING CAPACITY			
Swing Over Bed	mm inch	ø710 27.95"	
Swing Over Carriage	mm inch	ø545 21.46"	
Max. Turning Diameter	mm inch	ø320 12.6"	ø310 12.2"
Max. Turning Length	mm inch	570 22.44"	570 22.44"
MAIN SPINDLE			
Chuck Size		8"	
Spindle Nose		A2-6	
Spindle Front Bearing Inner Diameter	mm inch	ø110 4.33"	
Hole Through Spindle	mm inch	ø80 3.15"	
Hole Through Draw Tube	mm inch	ø66 2.6"	
Spindle Speed	rpm	5,000	
Max. Spindle Torque	kgf-m lb-ft	27 195.29	
C-axis Speed	rpm	50	
C-axis Index	deg	0.001°	
SUB SPINDLE			
Chuck Size		-	6"
Spindle Nose		-	A2-5
Spindle Front Bearing Inner Diameter	mm inch	-	ø90 3.54"
Hole Through Spindle	mm inch	-	ø55 2.17"
Hole Through Draw Tube	mm inch	-	ø45 1.77"
Spindle Speed	rpm	-	6,000
Max. Spindle Torque	kgf-m lb-ft	-	9.35 67.63
C-axis Speed	rpm	-	50
C-axis Index	deg	-	0.001°
MOTOR			
Main Spindle Motor	kW HP	18.5 / 22 / 30 25 / 30 / 40 (cont. / 30min. / S3 25%)	18.5 / 22 / 30 25 / 30 / 40 (cont. / 30min. / S3 25%)
Sub Spindle Motor	kW HP	-	7.5 / 11 10 / 15 (cont. / 30min.)
Axial Motor (X/Z/Y/B) (cont.)	kW HP	3 / 3 / 2.5 / 2.7	4 / 4 / 3.4 / 3.6
Turret Motor (cont.)	kW HP	2.5 3.4	
Live Tool Motor	kW HP	1.1 / 3.7 1.5 / 5 (cont. / 10min.)	
Live Tool Motor Speed	rpm	100~4,000	
TRAVEL			
X-axis Travel	mm inch	175 6.89"	160 6.3"
Z-axis Travel	mm inch	570 22.44"	570 22.44"
Y-axis Travel	mm inch	90 (+50 / -40) 3.54"(+1.97" / -1.57")	90 (+50 / -40) 3.54"(+1.97" / -1.57")
B-axis Travel	mm inch	570 / 650*1 22.44" / 25.59"	650 25.59"
Rapid Feedrate (X/Z/Y/B)	m/min ipm	30 / 36 / 10 / 20 1,181 / 1,417 / 394 / 787	
Cutting Feedrate (X/Z/Y/B)	mm/min ipm	1~10,000 0.04~394	
TURRET			
Turret Type		Radial Multitasking Turret (Servo Rotating / Hydraulic Clamp)	
Tool Stations	BMT T	12 (BMT55)	
Tool Type	Shank Height for Square Tool	□20 □3/4"	
	Shank Diameter for Boring Bar	ø32 ø1&1/4"	
TAILSTOCK			
Tailstock Quill Diameter	mm inch	ø75 / ø75 / ø90*1 ø2.95" / ø2.95" / ø3.54"*1	
Tailstock Quill Taper	Stationary Center (std.)	MT-4	
Tailstock Quill Travel	mm inch	100 / 100 / 0*1 3.94" / 3.94" / 0"*1	
Tailstock Stroke	mm inch	570 22.44"	
HYDRAULIC SYSTEM			
Pressure	kgf/cm ² psi	45 640	
Flow Rate	L/min gpm	50Hz : 31 8.19 60Hz : 37 9.78	
COOLANT			
Tank Capacity	L gal	270 71.33	350 92.47
Pump Motor	kW HP	0.75 1.01	0.75 1.01
GENERAL			
Machine Weight	kg lb	5,420 11,949	6,180 13,624

NT

		NT	
		2500SY	
		ø1,000 39.37"	
		(ø700 27.56" interference with cover)	
		ø870 34.25"	
		(ø700 27.56" interference with cover)	
		ø350 13.78"	
		686 27"	
			10"
			A2-8
			ø140 5.51"
			ø91 3.58"
			ø75 (ø80) 2.95"(ø3.15")
			3,500
			71.4 516.45
			50
			0.001°
			6"
			A2-5
			ø85 3.35"
			ø43 1.69"
			ø33 1.30"
			6,000
			6 43.4
			50
			0.001°
			15 / 22 20 / 29.5 (cont. / 30min.)
			5.5 / 7.5 7.4 / 10.1 (cont. / 30min.)
			4 / 4 / 3 / 3 5.4 / 5.4 / 4 / 4
			1.2 1.6
			3.7 / 5.5 5 / 7.4 (cont. / 15min.)
			4,500
			260 10.24"
			780 30.71"
			100 (±50) 3.94"(±1.97")
			770 30.31"
			20 / 24 / 10 / 20 787 / 945 / 394 / 787.4
			1~10000 0.4~394
			Radial Multitasking Turret (Servo Rotating / Hydraulic Clamp)
			12 (BMT65)
			□25 □1"
			ø40 / ø32 ø1&1/2" / ø1&1/4" (double boring holder)
			-
			-
			-
			-
			70 955.61
			50Hz : 21 5.55 60Hz : 25 6.61
			420 110.96
			1.15 2.02
			7,450 16,424

SPECIFICATIONS

Above specifications may vary depending on the machine and the surrounding environment. The manufacturer reserves the right to modify the design, specifications, mechanisms, etc., to improve the performance of the machine without notice. The test data provided in this catalog is performed under specific test procedures and environmental conditions. Remark*1: The dimension or data of the servo tail stock. The servo tail stock is an option.

ACCESSORIES

GT

● : Standard ○ : Optional - : Not applicable

ITEMS			GT					
			200MA	200B	250MA	250B	300B	300MA/ LMB
Turret	Std. Tool	8T	-	-	-	-	●	-
		10T	-	●	-	●	○	-
		12T	-	○	-	○	-	-
	VDI	12T	● VDI30	○ VDI30	● VDI40	○ VDI40	○ VDI40	● VDI40
Chuck & Jaw	Hard Jaws and Soft Jaws 1 set	Standard	●	●	●	●	●	●
		Big Bore	-	-	○	-	-	-
	Chuck Switch Pedal	Spindle	●	●	●	●	●	●
Tailstock	Tailstock	Manual Tailstock	●	●	●	●	●	●
		Programmable Tailstock	-	-	○	○	○	○
	Tailstock Pedal		○	○	○	○	○	○
Coolant System	Coolant Pump*1	3.2 bar	●	●	●	●	●	●
		4.5 bar	○	○	○	○	○	○
		14.1 bar	-	-	○	○	○	○
Chip Removal System	Chip Conveyor	Right Side / Rear Side	● / ○	● / ○	● / ○	● / ○	● / ○	● / ○
	Air Gun		●	●	●	●	●	●
	Coolant Gun		○	○	○	○	○	○
Electrical System	Electrical Cabinet	Heat Exchanger	●	●	●	●	●	●
		A/C. Cooler	○	○	○	○	○	○
Auxiliary System	Air Blast		○	○	○	○	○	○
	Automatic Lubrication	Piston Type	●	●	●	●	●	●
	Hydraulic System		●	●	●	●	●	●
	Oil Mist Collector		○	○	○	○	○	○
Peripherals	Oil Skimmer		○	○	○	○	○	○
	Auto Tool Length Measurement System	RENISHAW HPMA	○	○	○	○	○	○
	Bar Feeder		○	○	○	○	○	○
	Parts Catcher		○	○	○	○	○	○
	Part Conveyor		○	○	○	○	○	○
Others	Complete Chip Enclosure		●	●	●	●	●	●
	Foundation Bolts		○	○	○	○	○	○
	Leveling Blocks & Screws		●	●	●	●	●	●
	Safety Clutch	X-Axis	○	○	○	○	○	○
		Z-Axis	○	○	○	○	○	○
	Steady Rest	Manual	-	-	-	-	○	○
Hydraulic		-	-	○	○	○	○	
CNC Control	FANUC	TXP-100FA	-	●	-	●	●	-
		TXP-200FA	●	○	●	○	○	●

The specifications and information are subject to change without prior notice. For more details, please contact YCM sales representative.
 Remark*1: The above specifications are the coolant pump at the flow rate of 40L /min with the electric power of 60Hz. The results may be different if the electric power changes to 50Hz. For more details, please contact YCM sales representative.

ITEMS			TC			
			16LA	16LB	26	36
Spindle	Spindle Cooling System		-	-	-	-
Turret	Std. Tool	8T	-	-	○	○
		10T	○	●	○	○
		12T	●	○	●	●
	VDI	10T	-	-	○ VDI40	○ VDI40
		12T	○ VDI30	○ VDI30	○ VDI40	○ VDI40
Chuck & Jaw	Hard Jaws and Soft Jaws 1 set	Standard	●	●	●	●
	Chuck Switch Pedal	Spindle	●	●	●	●
Tailstock	Tailstock	Manual Tailstock	●	●	-	-
		Programmable Tailstock	-	-	●	●
	Tailstock Pedal		○	○	○	○
Coolant System	Coolant Pump*1	3.2 bar	-	-	●	●
		4.5 bar	-	-	○	○
		14.1 bar	○	○	★	○
		3.7 bar	●	●	-	-
Chip Removal System	Chip Conveyor	Right Side / Rear Side	● / ○	● / ○	●	●
	Air Gun		●	●	●	●
	Coolant Gun		○	○	○	○
Electrical System	Electrical Cabinet	Heat Exchanger	●	●	●	●
		A/C. Cooler	○	○	○	○
Auxiliary System	Air Blast		○	○	○	○
	Automatic Lubrication	Piston Type	●	●	●	●
	Hydraulic System		●	●	●	●
	Oil Mist Collector		○	○	○	○
Peripherals	Oil Skimmer		○	○	○	○
	Auto Tool Length Measurement System	RENISHAW HPM A	○	○	○	○
	Bar Feeder		○	○	○	-
	Parts Catcher		○	○	○	-
	Part Conveyor		○	○	○	-
Others	Complete Chip Enclosure		●	●	●	●
	Foundation Bolts		○	○	○	○
	Leveling Blocks & Screws		●	●	●	●
	Safety Clutch	X-Axis	-	-	○	○
		Z-Axis	-	-	●	●
	Steady Rest	Manual	-	-	○	○
Hydraulic		-	-	○	○	
CNC Control	FANUC	TXP-100FA	●	●	●	●
		TXP-200FA	-	-	○	○

The specifications and information are subject to change without prior notice. For more details, please contact YCM sales representative.
 Remark*1: The above specifications are the coolant pump at the flow rate of 40L /min with the electric power of 60Hz. The results may be different if the electric power changes to 50Hz. For more details, please contact YCM sales representative.

ITEMS			TC				
			46/ 1000	46/ 1650	46/ 2300	46/ 3200	46M/ 3200
Spindle	Spindle Cooling System		●	●	●	●	●
Turret	Std. Tool	10T	●	●	●	●	–
		12T	○	○	○	○	–
	BMT 85	12T	–	–	–	–	●
Chuck & Jaw	Hard Jaws and Soft Jaws 1 set	Standard 15"/18"/21"	●/○/○	●/○/○	●/○/○	●/○/○	●/○/○
		Big Bore*2 18"/21"/24"	●/○/○	●/○/○	●/○/○	●/○/○	●/○/○
	Chuck Switch Pedal	Spindle	●	●	●	●	●
Tailstock	Tailstock	Programmable Tailstock	●	●	●	●	●
	Tailstock Pedal		○	○	○	○	○
Coolant System	Coolant Pump*1	4.6 bar	●	●	●	●	●
		14.1 bar	○	○	○	○	○
		18.5 bar	○	○	○	○	○
Chip Removal System	Chip Conveyor	Right Side	●	●	●	●	●
	Air Gun		●	●	●	●	●
	Coolant Gun		○	○	○	○	○
Electrical System	Electrical Cabinet	Heat Exchanger	●	●	●	●	●
		A/C. Cooler	○	○	○	○	○
Auxiliary System	Air Blast		○	○	○	○	○
	Automatic Lubrication	Piston Type	●	●	●	●	●
	Hydraulic System		●	●	●	●	●
	Oil Mist Collector	1 set	○	○	–	–	–
2 sets		–	○	○	○	○	
Peripherals	Oil Skimmer		○	○	○	○	○
	Auto Tool Length Measurement System	RENISHAW HPMA	○	○	○	○	○
Others	Complete Chip Enclosure		●	●	●	●	●
	Foundation Bolts		○	○	○	○	○
	Leveling Blocks & Screws		●	●	●	●	●
	Safety Clutch	X-Axis	○	○	○	○	○
		Z-Axis	○	○	○	○	○
	Steady Rest	Manual*3	○	○	○	○	○
Hydraulic		○	○	○	○	○	
CNC Control	FANUC	TXP-100FA	●	●	●	●	–
		TXP-200FA	○	○	○	○	●

The specifications and information are subject to change without prior notice. For more details, please contact YCM sales representative.
 Remark*1: The above specifications are the coolant pump at the flow rate of 40L/min with the electric power of 60Hz. The results may be different if the electric power changes to 50Hz. For more details, please contact YCM sales representative.
 Remark*2: TC-46 Big bore series: Head drive structure is identical with TC-46M, plugged with 2 speed gear box.
 Remark*3: Wide selection of manual steady rest available: ø40~250 and ø250~460 mm.

NTC

● : Standard ○ : Optional - : Not applicable

NT

ITEMS			NTC		NT	
			2000LY	2000LSY	-2500SY	
Spindle	Sub Spindle		-	●	●	
Turret	BMT55	12T	●	●	-	
	BMT65	12T	-	-	●	
Chuck & Jaw	Hard Jaws and Soft Jaws 1 set		●	●	●	
	Chuck Switch Pedal	Spindle	●	●	●	
		Sub spindle	-	●	●	
Tailstock	Tailstock	Stationary Quill	●	-	-	
		Programmable	○	-	-	
		Manual	●	-	-	
		Servo	○	-	-	
	Tailstock Pedal		○	-	-	
Coolant System	Coolant Pump*1	5.4 bar	-	-	●	
		6.5 bar	-	-	○	
		14.1 bar	○	○	○	
		3.7 bar	●	●	-	
Chip Removal System	Chip Conveyor	Right Side / Rear Side	● / ○	● / ○	● / ○	
	Air Gun		●	●	●	
	Coolant Gun		○	○	○	
Electrical System	Electrical Cabinet	Heat Exchanger	●	●	●	
		A/C. Cooler	○	○	○	
Auxiliary System	Air Blast	Spindle	○	●	●	
		Sub spindle	-	●	●	
	Automatic Lubrication	Piston Type	●	●	●	
	Hydraulic System		●	●	●	
	Oil Mist Collector		○	○	○	
Peripherals	Oil Skimmer		○	○	○	
	Auto Tool Length Measurement System	RENISHAW HPMA	○	○	○	
	Bar Feeder		○	○	○	
	Parts Catcher	Spindle	○	-	○	
		Sub spindle	-	○	○	
	Parts Pusher		-	○	○	
	Part Conveyor		○	○	○	
Others	Complete Chip Enclosure		●	●	●	
	Foundation Bolts		○	○	○	
	Leveling Blocks & Screws		●	●	●	
	Safety Clutch	X \ Z-Axis		○	○	●
		Y-Axis		-	-	○
B-Axis		○	○	○		
CNC Control	FANUC	TXP-200FA	●	●	-	
		TXP-200FB	-	-	●	

The specifications and information are subject to change without prior notice. For more details, please contact YCM sales representative.
 Remark*1: The above specifications are the coolant pump at the flow rate of 40L/min with the electric power of 60Hz. The results may be different if the electric power changes to 50Hz. For more details, please contact YCM sales representative.